

Detection of LAr scintillation light

Ettore Segreto
UNICAMP

UK-Latin America Workshop - December, 21 2018



Scintillation light in Liquid Argon (I)

- The interactions of ionizing particles in LAr cause the formation of both electron-hole (ion) pairs e^- - Ar^+ and excited atoms Ar^* ($Ar^*/Ar^+ \sim 0.21$).
- Both states lead to the formation (with times of the order of tens of picoseconds) of the excited dimer Ar_2^* ($^1\Sigma_u$ singlet state and $^3\Sigma_u$ triplet state)
- The de-excitation of the excited dimer: $Ar_2^* \rightarrow 2Ar + \gamma$ produces a Vacuum Ultra Violet (VUV) photon with $\lambda = 128 \text{ nm}$ ($\sigma \sim 3 \text{ nm}$).
- The absolute photon yield depends on the type of ionizing radiation and on its Linear Energy Transfer (LET). For minimum ionizing particles (mip) the photon yield has been measured to be $\sim 4 \times 10^4 \gamma/\text{MeV}$.

Scintillation light in Liquid Argon (II)

- Time dependence of the scintillation light emission of pure LAr:

$$\lambda(t) = \frac{A_S}{\tau_S} \exp\left(\frac{-t}{\tau_S}\right) + \frac{A_T}{\tau_T} \exp\left(\frac{-t}{\tau_T}\right)$$

$$\tau_S(^1\Sigma_u) = 2 - 6 \text{ nsec}$$

$$\tau_T(^3\Sigma_u) = 1100 - 1600 \text{ nsec}$$

$$\int I(t) dt = A_S + A_T = 1$$

A_S/A_T depends on ionizing radiation (PSD discrimination).

An intermediate component with $\tau_i \sim 40 \text{ ns}$ has been sometimes reported in literature.

Quenching by N₂ residual contamination

- Residual contaminations (@ ppm level) of N₂, O₂, H₂O, CO and CO₂ (even in best grade commercial LAr) can lead to a substantial reduction of the scintillation yield;
- Argon purification systems (Oxygen reactants and molecular sieves) are known to reduce O₂, H₂O, CO and CO₂ at a negligible level;
- Methods for removing the N₂ residual content are instead less commonly used in experimental applications

Quenching process by N₂ molecules

The quenching process can be sketched as:

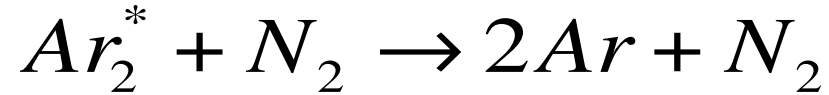

this non-radiative collisional reaction prevents the formation of a VUV photon.

- Time dependence of the scintillation light emission of N₂-contaminated LAr:

$$\lambda'(t) = \frac{A'_S}{\tau'_S} \exp\left(\frac{-t}{\tau'_S}\right) + \frac{A'_T}{\tau'_T} \exp\left(\frac{-t}{\tau'_T}\right)$$

$$\int \lambda'(t) dt = A'_S + A'_T \leq 1$$

$$Q_F = A'_S + A'_T \quad 0 \leq Q_F \leq 1$$

$$\frac{1}{\tau'_j}([N_2]) = \frac{1}{\tau_j} + k_j[N_2]$$
$$A'_j([N_2]) = \frac{A_j}{1 + \tau_j k_j [N_2]}$$

Example of waveform collected during the test

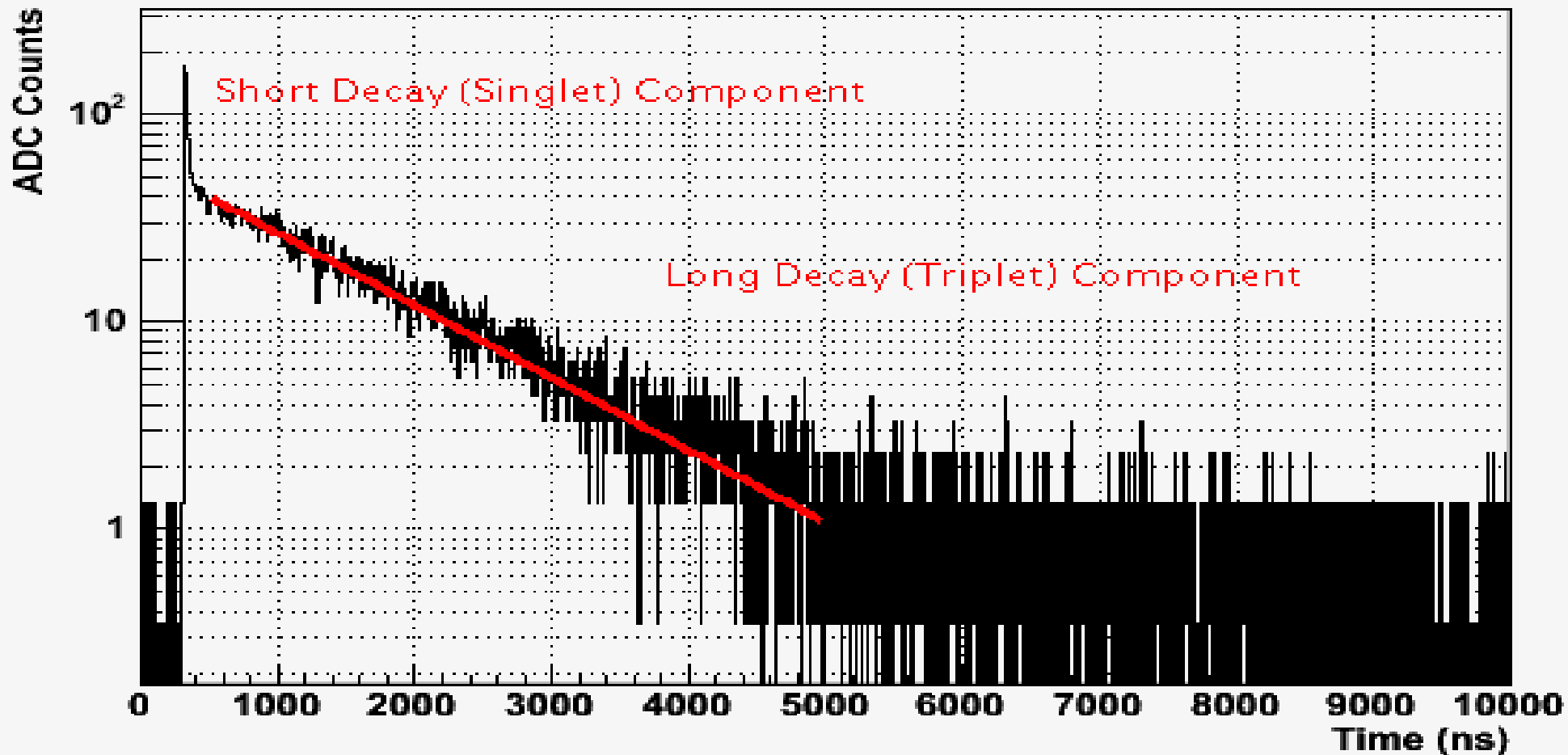

Evidence for a third component

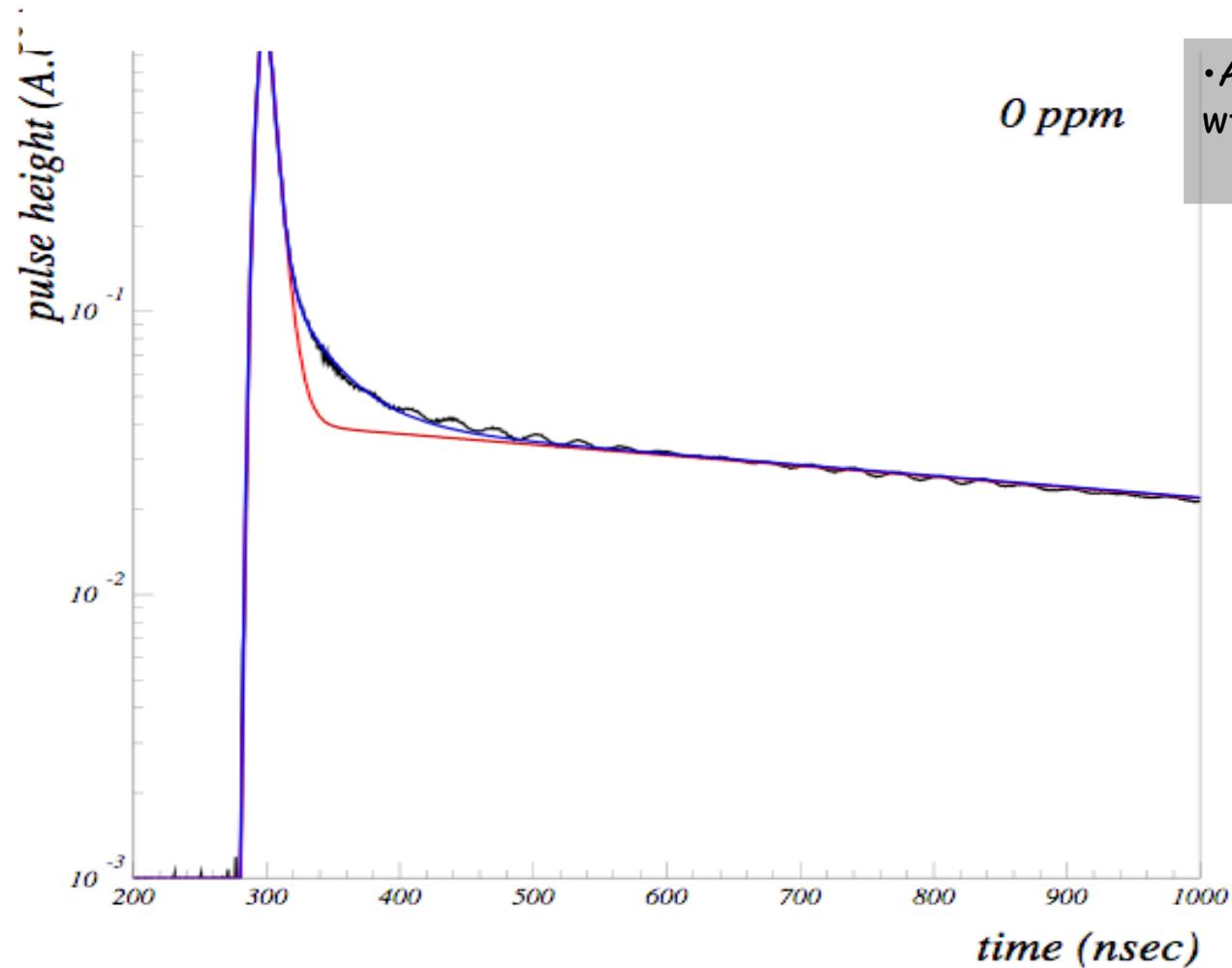

- Attempts to perform a fit of the average wfm with a two component signal failed.

Signal shape

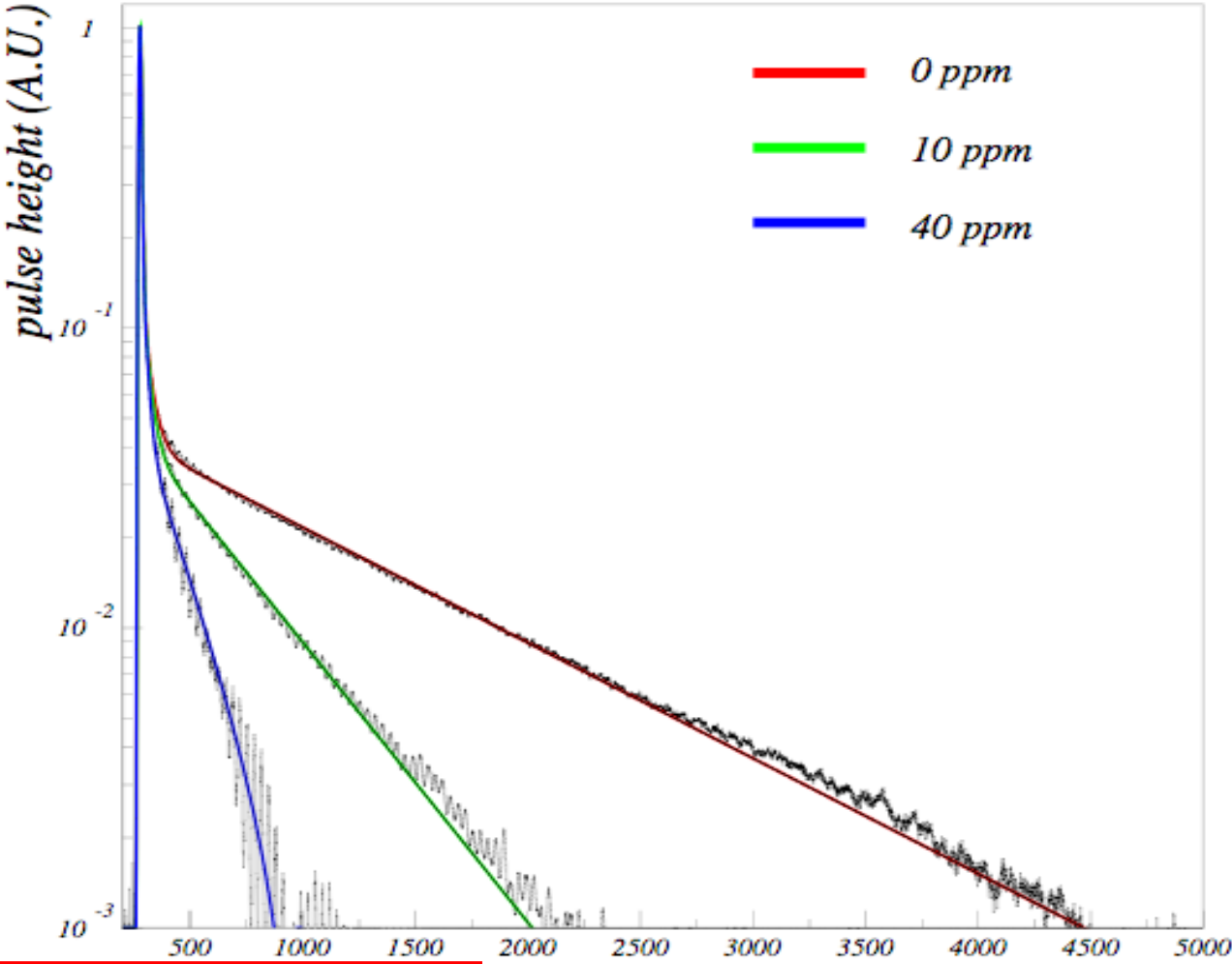

Examples of average light signals

time (nsec)

Signal amplitude

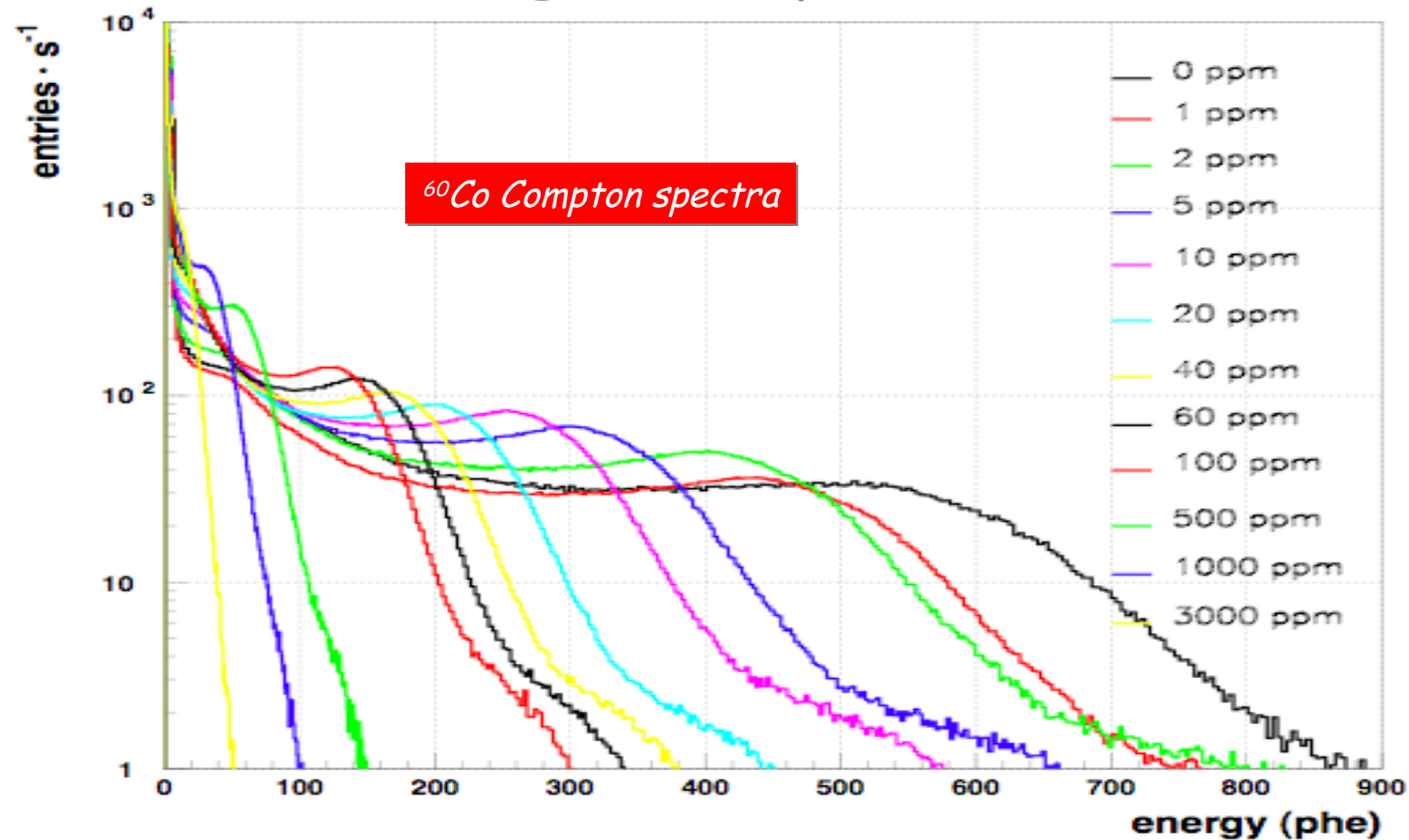

The Quenching Factor

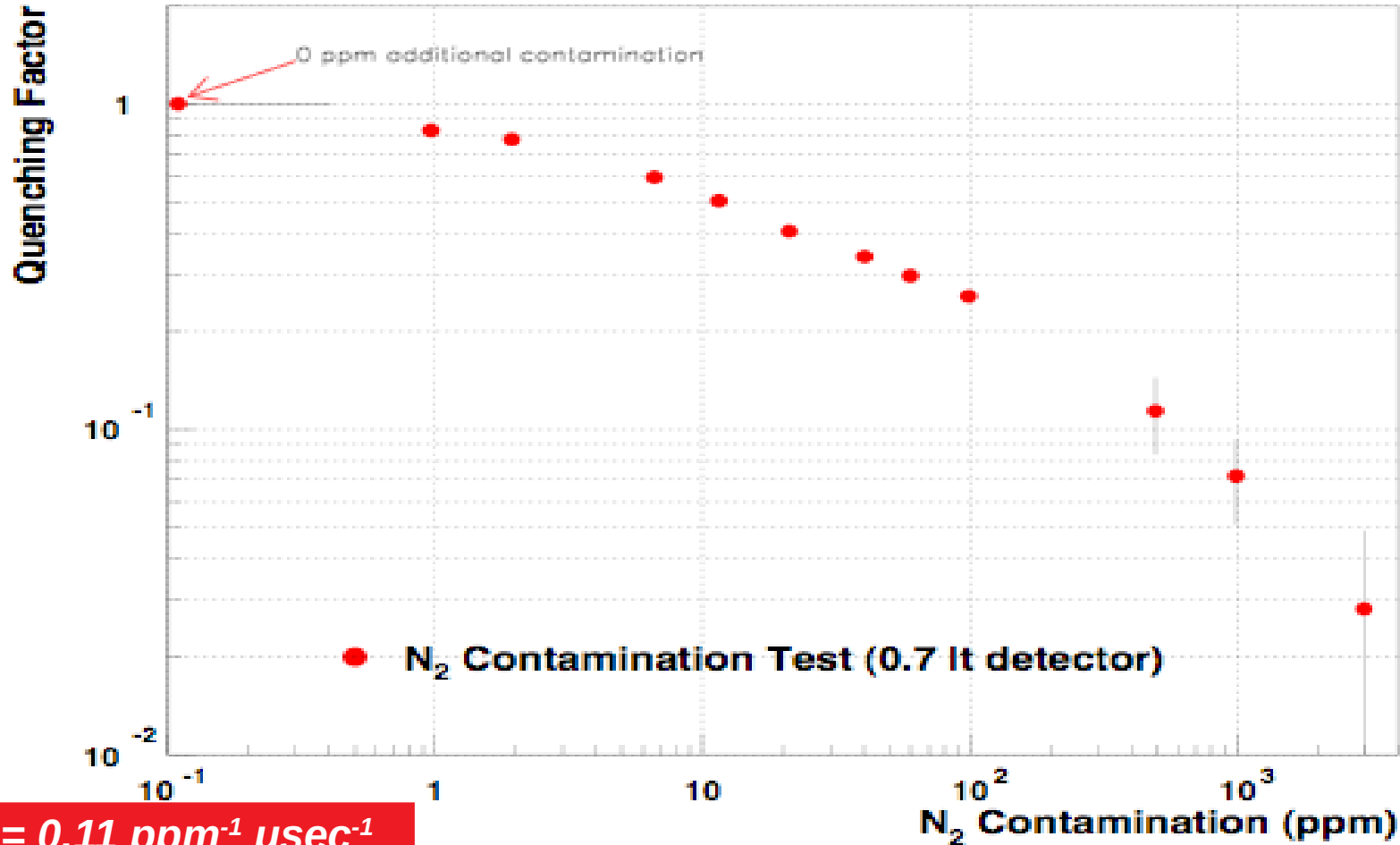

Quenching process by O_2 molecules

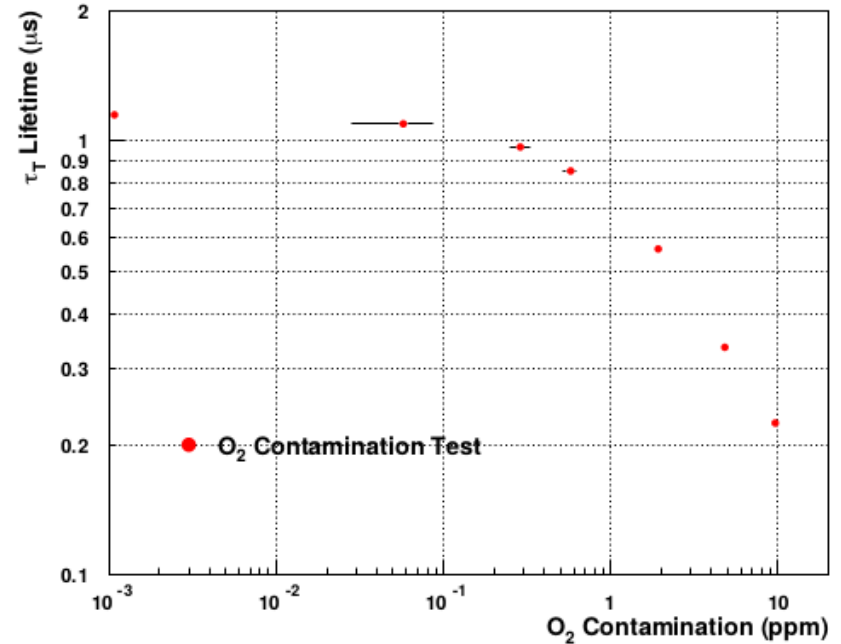
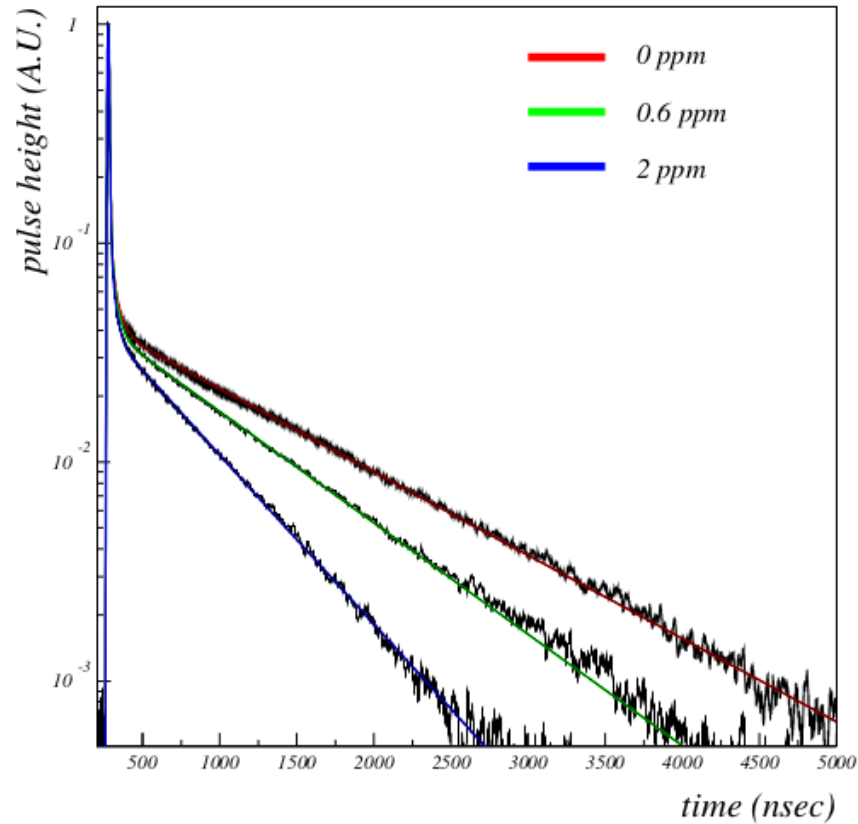

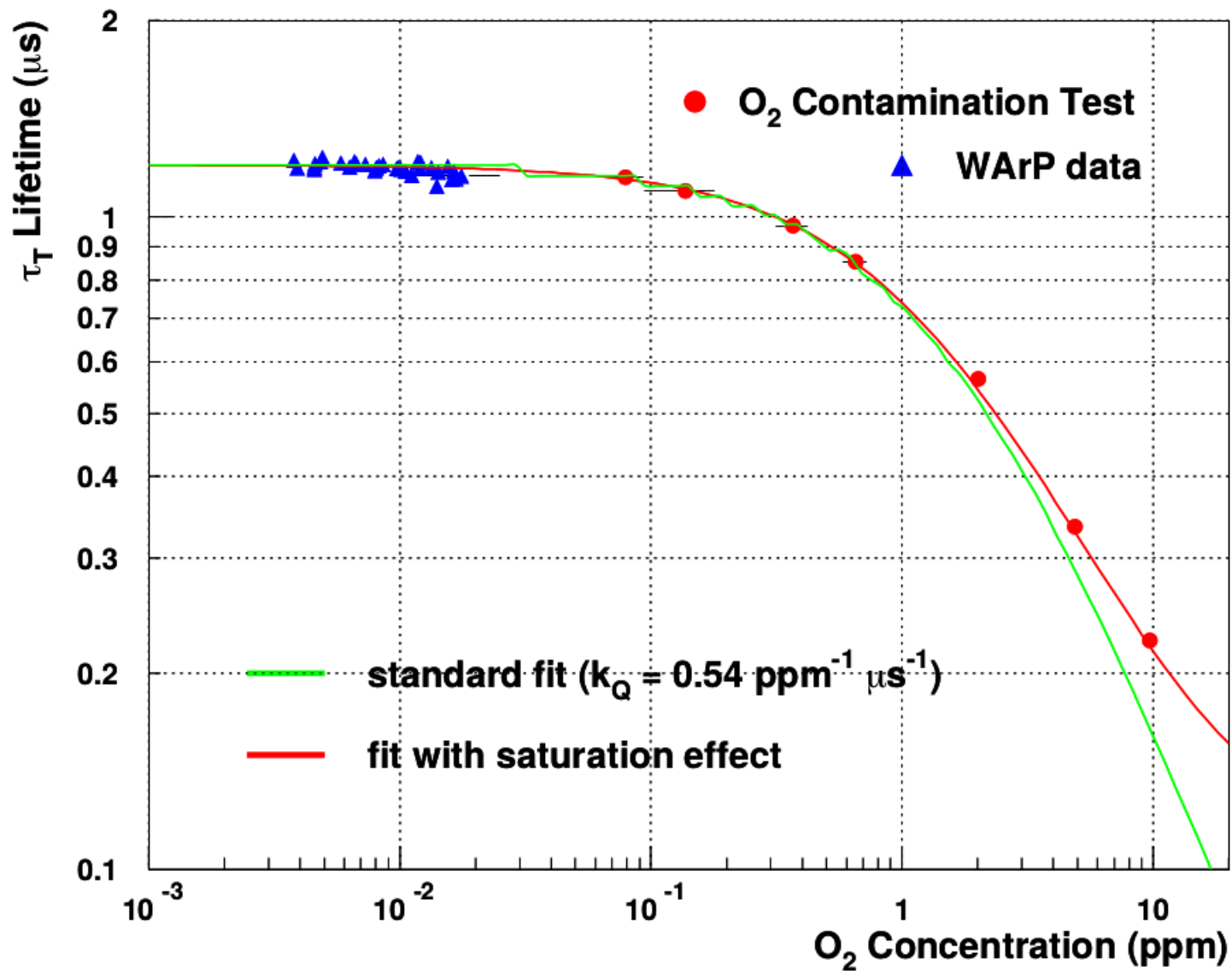

Quenching factor and attenuation

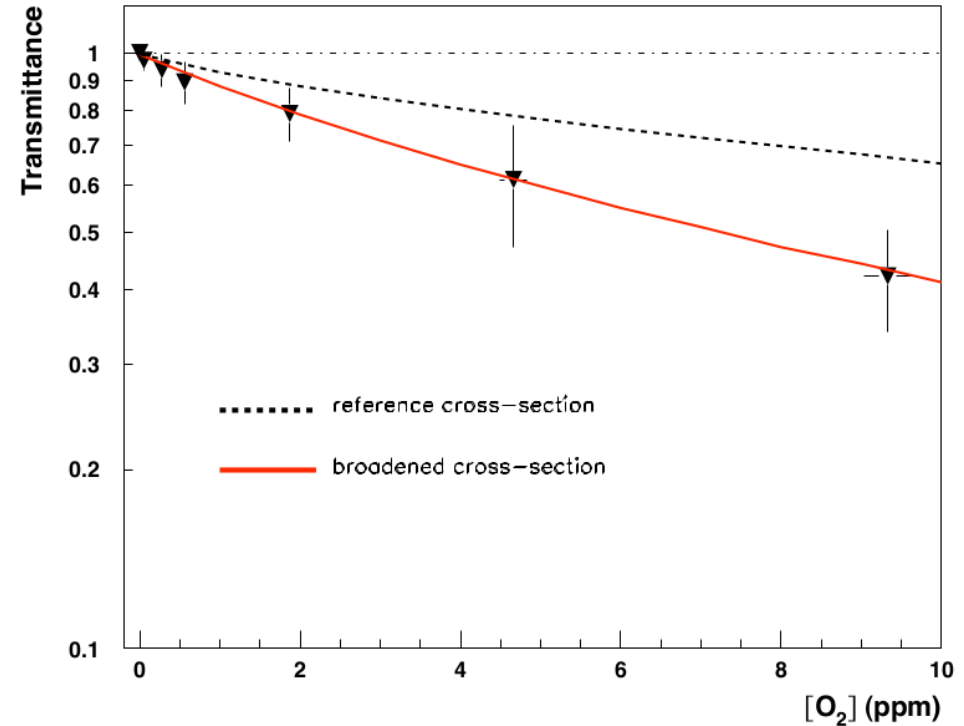
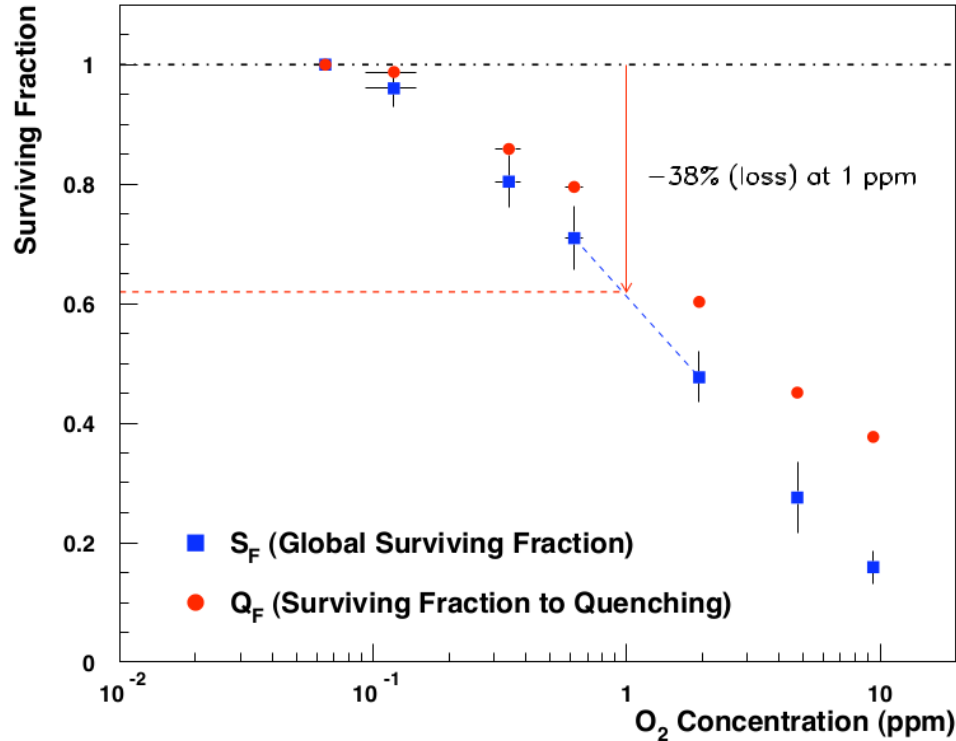

*The photo-absorption coefficient (averaged around 128 nm)
 $k A (O_2) = 0.034 \pm 0.016 \text{ ppm}^{-1} \text{ cm}^{-1}$ (1 ppm corresponds to 30 cm attenuation length)*

Paradigm of light detection

- Scintillation light is shifted by **TetraPhenyl Butadiene** (TPB)
- Shifted light is *detected by photomultipliers/Silicon devices*
- TPB absorbs VUV scintillation light and re-emits it around **430 nm**
- ***TPB is usually assumed to convert light within 1 ns from its absorption***
- *Detected light should have the same features of LAr scintillation light*

...but

- Detected scintillation waveforms *always show* an **intermediate component**, between the 6 ns and 1300 ns ones, with a characteristic decay time **~ 50-100 ns**
- **The decay time of the slow component** of scintillation light has an 'indefinite value' **ranging from 1200 to 1600 ns**
- **TPB could have a conversion efficiency** for VUV photons **higher than 100%**.
- **The pulse shape parameter** requires an integration of the initial part of the waveform **for ~ 100 ns**

Is there a 'fil rouge' linking these
anomalies?

TPB is still a bit unknown object

- The **conversion efficiency** and the **spectral properties** have been recently measured by several authors (not all results are compatible among each other)
- But there is **not an exact knowledge** of **its response function in time**
- It is usually extrapolated from the one measured *with near UV radiation* ($\lambda \sim 350$ nm), that is a fast decaying exponential. It is compatible with the **photo-excitation** of highly excited singlet states of the TPB molecule (S_n). They decay *very fast* (< 1 ns) *non-radiatively* to the *lowest lying singlet state* (S_1) whose de-excitation to the ground state produces the shifted light - around 430 ns
- Does it hold at any wavelength?

NO:TPB ionization!

- Probably, a less known information is that **the ionization potential of TPB is quite low. It is between 5 and 6 eV**
- This is **lower than the energy of LAr scintillation photons - 9.7 eV**
- TPB molecules are **ionized** and electrons have enough energy to *excite some of the surrounding molecules*
- Both *singlet* and *triplet states* are formed (also in the electron-ion recombination)
- *Singlet states decay very fast to the ground state* emitting a prompt shifted photon
- **Triplet states** are responsible of a **delayed scintillation** through the **triplet-triplet interaction: $T_1+T_1 \rightarrow S_1+S_0$** and **a photon is emitted with the same wavelength of the prompt component**
- *We should expect a delayed scintillation in TPB excited by VUV photons - as already observed for sodium-salicylate and p-terphenyl*

TPB response function to 127 nm photons

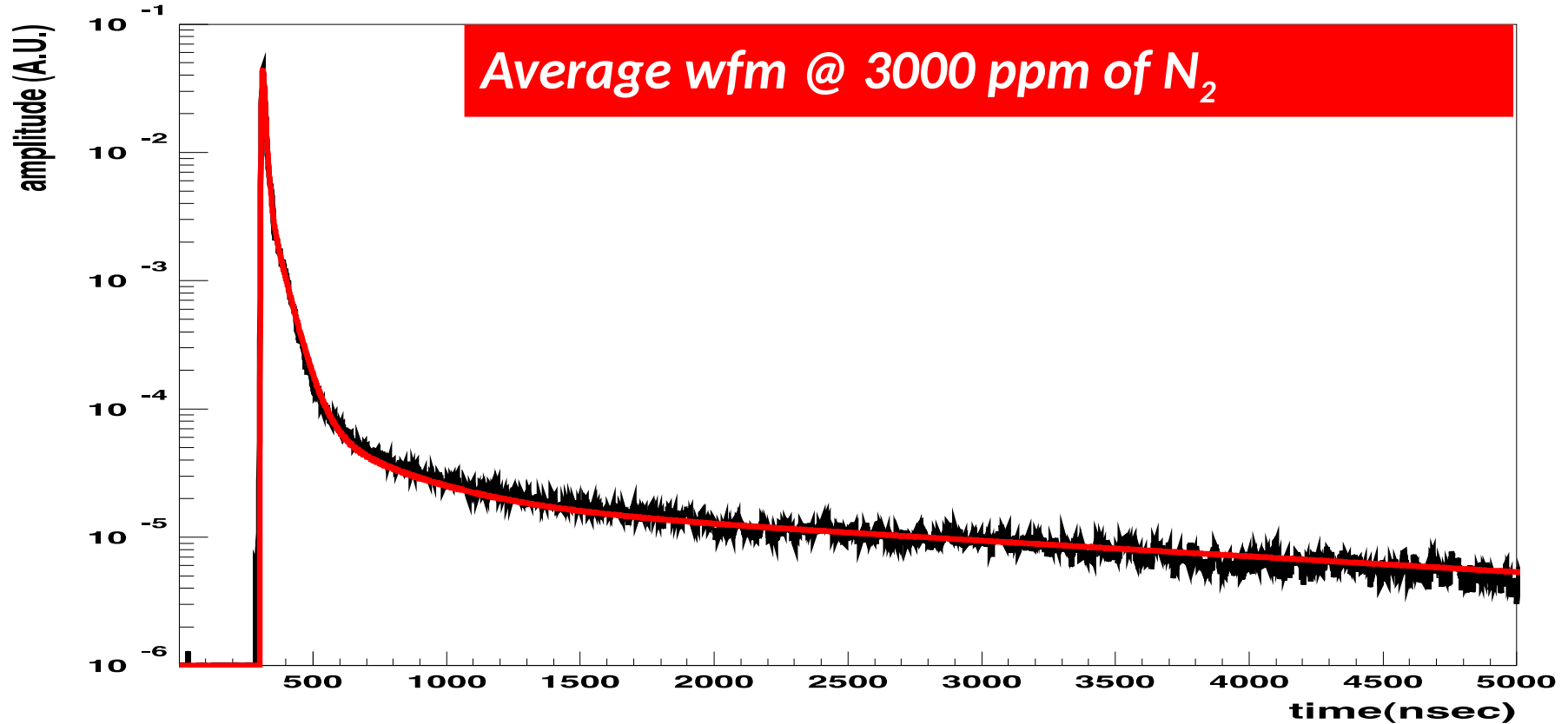

Decay times

- Even if not formally correct the time response of TPB has been fitted with four decaying exponentials

	decay time (ns)	abundance (%)
Instantaneous component	1-10	60 ± 1
Intermediate component	49 ± 1	30 ± 1
Long component	3550 ± 500	8 ± 1
Spurious component	309 ± 10	2 ± 1

Average waveforms

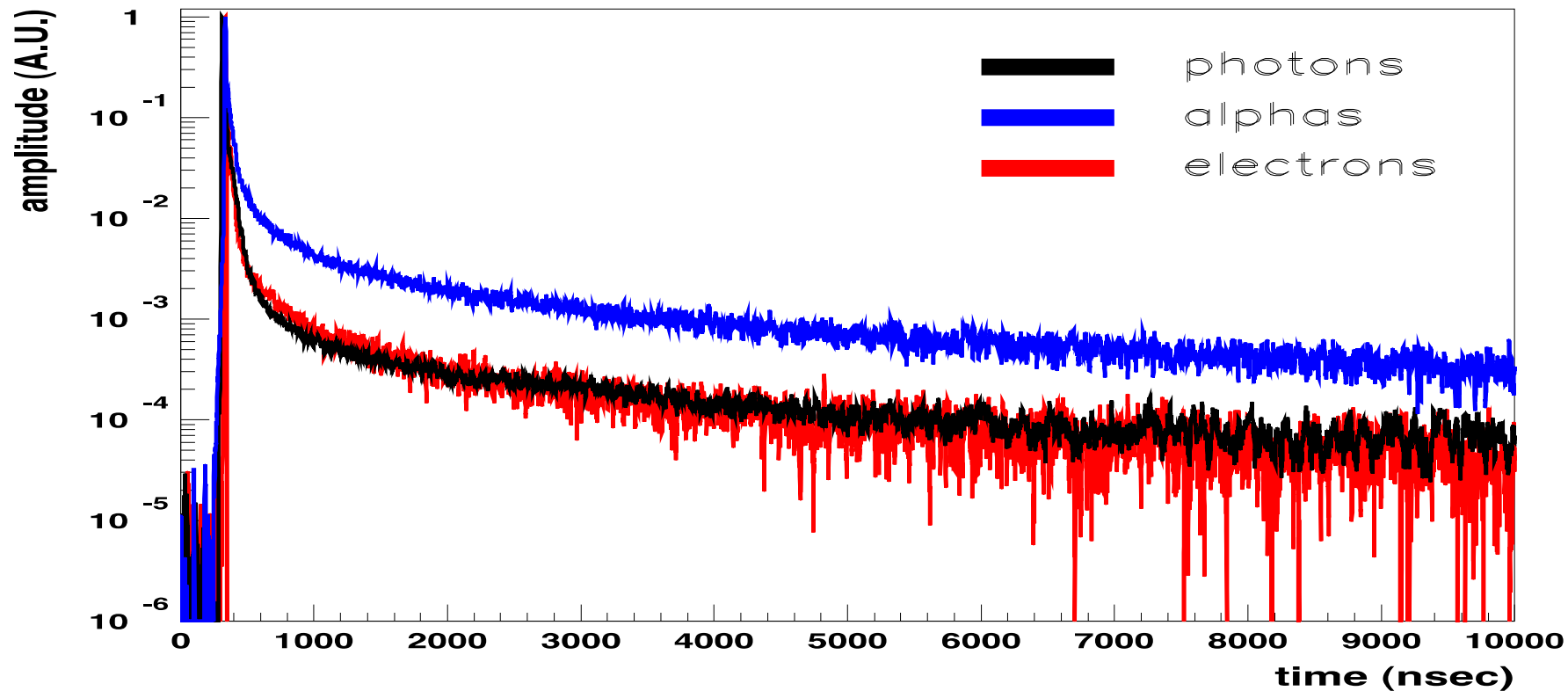

Black wfm is the one measured with *LAr scintillation photons*

Red and **Blue** wfms come from TPB direct excitation with *betas* and *alphas* in vacuum

Consequences...

- The **time evolution** of LAr scintillation light can be described *as the sum of only two decaying exponentials*, no exotic mechanisms are needed
- The observation of **an intermediate component** with a decay slope in the range of 50–100 ns often reported in the literature **can be totally ascribed to the fluorescence of TPB**
- **Conversion efficiencies of TPB > 100%** can be explained by the **ionization of TPB** molecules that can produce **more than one excitation per time**
- **The long tail in the TPB response function**, resembling a 3.5 μs exponential, **distorts the slow component of LAr scintillation** photons and any technique to measure its decay constant brings inside a certain amount of uncontrolled systematics if the effect of TPB is not properly deconvolved

Pulse Shape Discrimination I

$$F_{\text{prompt}} = \frac{\int_0^{t^*} I(t) dt}{\int_0^{\infty} I(t) dt},$$

$$L(t) = A * S(t) + (1-A) * T(t)$$

S(t) and T(t) convolution of TPB response and singlet and triplet decay

$$S(t^*) = T(t^*)$$

graphical solution →

If one ideally detected VUV photons

$$t^* = \tau_S \ln \frac{\tau_T}{\tau_S}, \sim 32 \text{ ns}$$

Inconsistent with experiments

***t** is always found in the range of 100 ns**

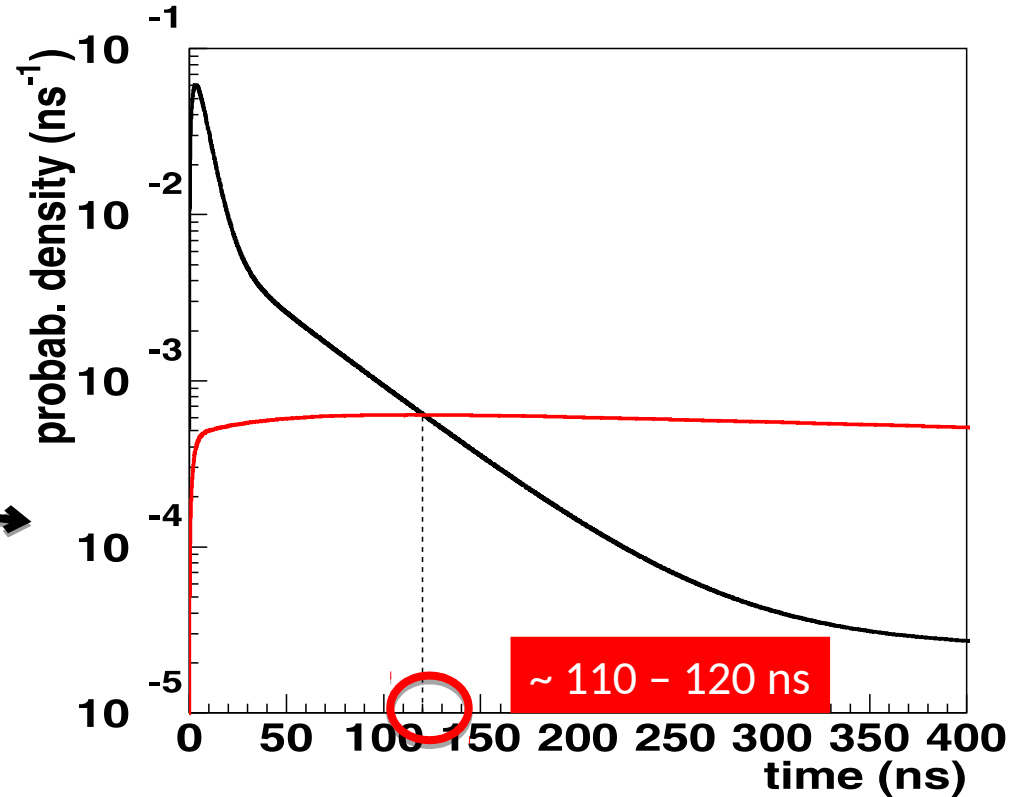

Pulse Shape Discrimination II

- The delayed fluorescence of TPB has also the effect of **deteriorating the discrimination capability of LAr** that could be obtained in the ideal case of a direct detection of the VUV photons
- *A fraction of the prompt light is delayed and the two LAr scintillation components are more mixed*
- **Without shifter**, the average value of F_{prompt} for electrons and neutrons can be calculated. Assuming a fraction A for the prompt scintillation of electrons and neutrons of **0.25 and 0.75** and considering a value of t^* of **32 ns**, $F_{prompt} = 0.27$ for e^- and **0.75** for neutrons, with a difference of **0.48**
- **With TPB** a numerical integration of the p.d.f. up to $t_* = 110$ ns leads to F_{prompt} values of **0.27 and 0.67** for electrons and neutrons with a difference of **0.4**
- **The use of the shifter worsens the separation between electrons and neutrons by about 17%**

DETECTION

Photomultipliers

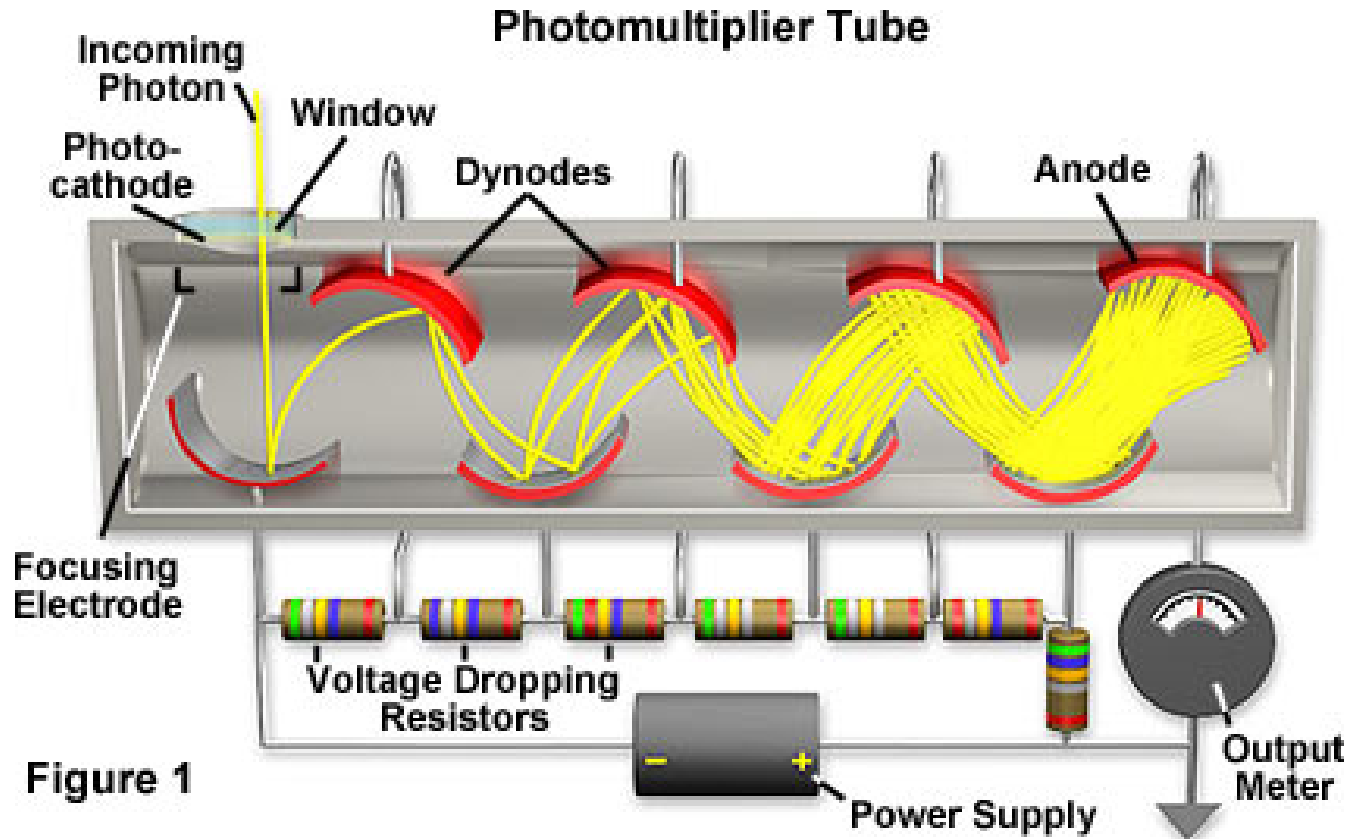
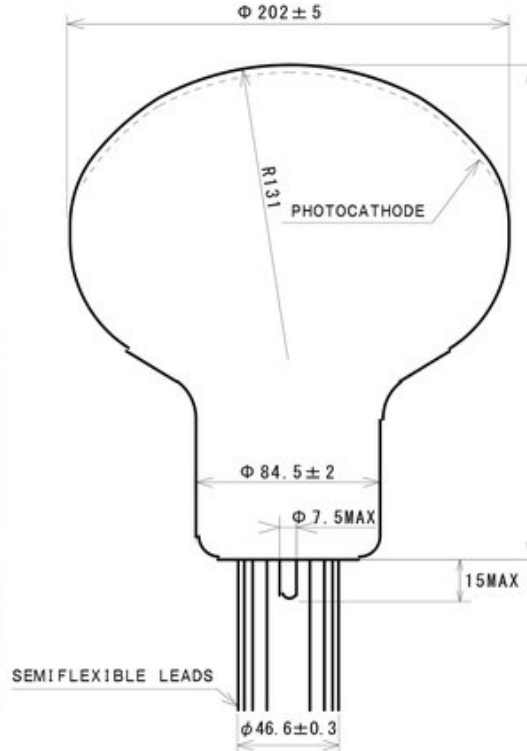

Figure 1

- *Well known and mastered technology*
- *Good detection efficiency (10 – 30%)*
- *Needs high voltage (1000 – 3000 Volt)*
- *Typically large devices which occupies a big volume*
- *Not so easy to make them radiopure*

Hamamatsu R5912



Spectral Response	300 ÷ 650 nm
Window Material	Borosilicate glass (sand blasted)
Photocathode	Bialkali with Pt under-layer
Max supply voltage (anode-cathode)	2000 V
Photocathode Q.E. at 420 nm	≥ 16%
Typical Gain	1×10^7 at 1500 V
Nominal anode pulse rise time*	≤ 4 ns
Nominal P/V ratio*	2.5
Max. dark count rate*	5000 s^{-1}
Max. transit time variation	2.5 ns (center-border)

* Values for $G = 1 \times 10^7$

Hamamatsu R11065



HAMAMATSU

TENTATIVE DATA SHEET

Mar. 2009

PHOTOMULTIPLIER TUBE

R11065

For Low Temperature Operation down to -186 deg. C
Special Bialkali Photocathode (Bialkali LT), Low Radioactivity
76 mm (3 Inch) Diameter, 12-stage, Head-on Type, Synthetic Silica

General

Parameter		Description / Value	Unit
Spectral response		160 to 650	nm
Wavelength of Maximum Response		420	nm
Window material		Synthetic silica	-
Photocathode	Material	Bialkali	-
	Minimum Effective Area	64	mm dia.
Dynode	Structure	Box & Linear-focused	-
	Number of Stages	12	-
Operating Ambient Temperature		-186 to +50	deg. C
Storage Temperature		-186 to +50	deg. C

Silicon Photomultipliers

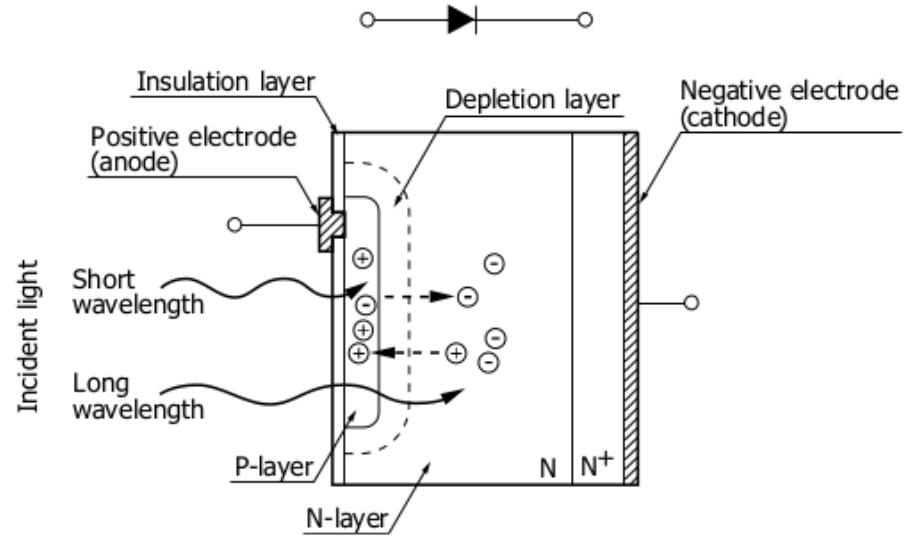
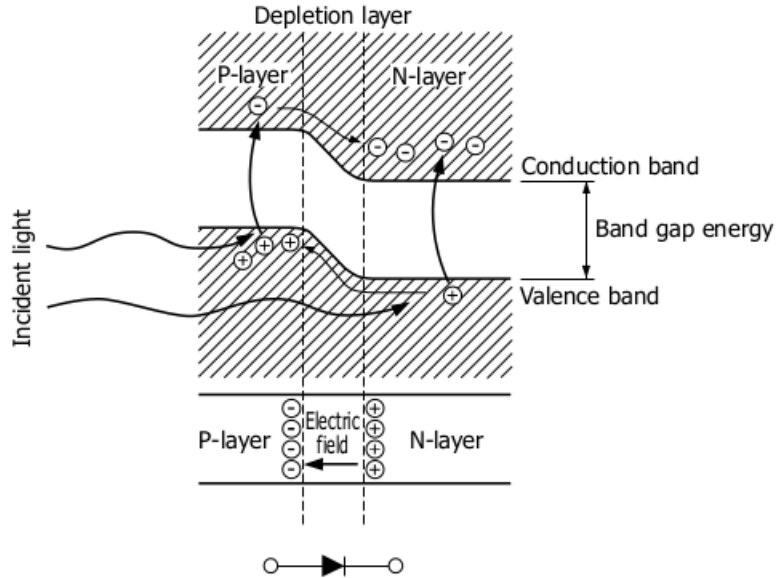

KPDC0002EA

KAPDC0071EB

Members of a larger family with PIN diode and APD (Avalanche Photo Diode). They differ for the amplification mechanism

Hamamatsu handbook: https://www.hamamatsu.com/resources/pdf/ssd/mppc_kapd9005e.pdf

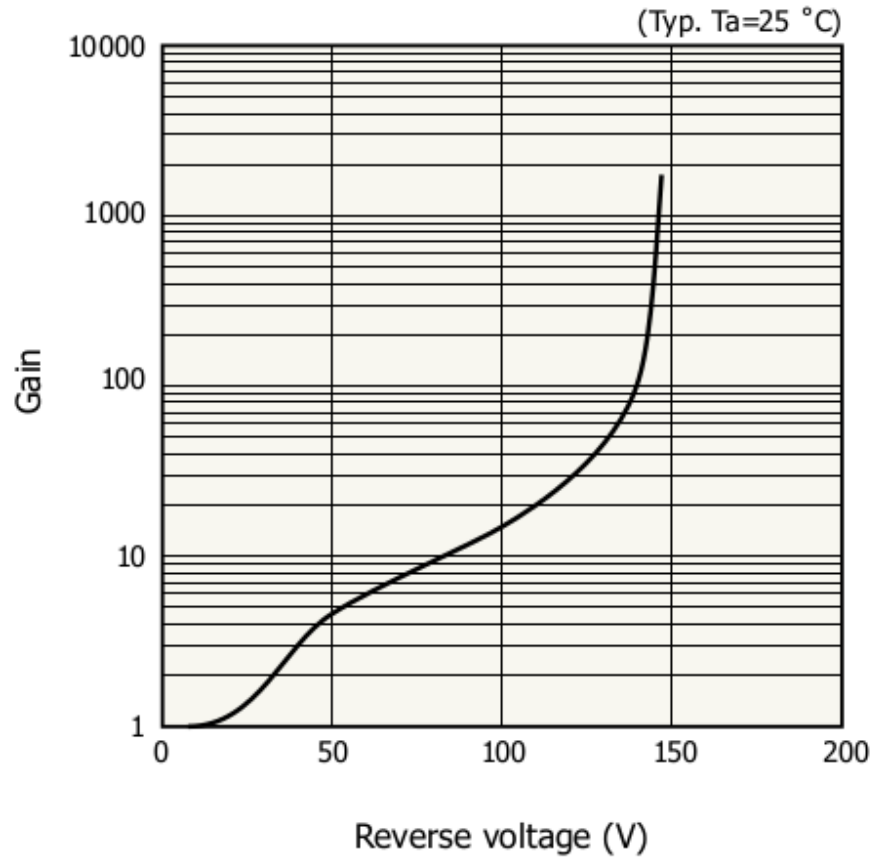

KAPDB0088EA

APD gain vs Reverse Voltage

Silicon Photomultipliers equivalent circuit

APD working in Geiger mode → digital device!

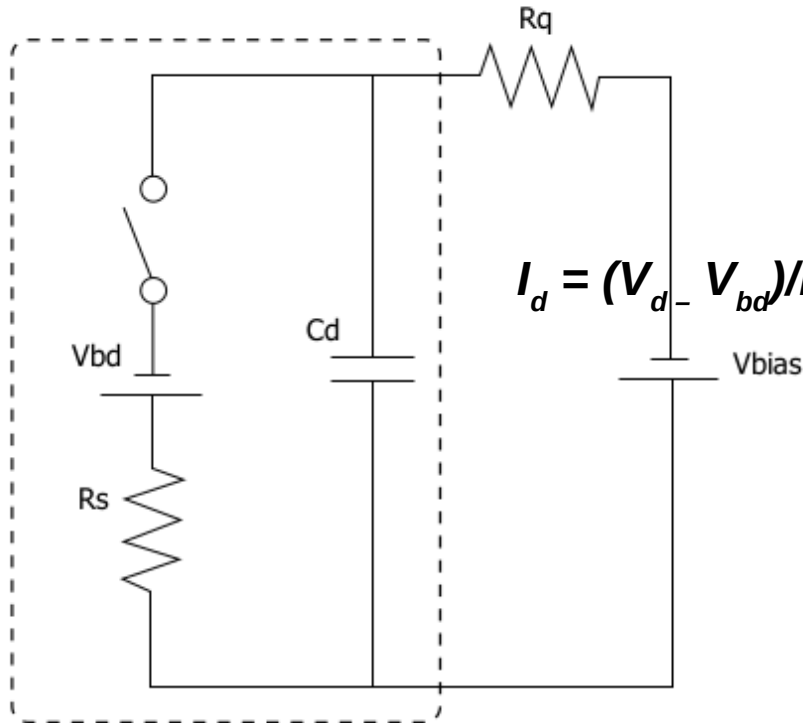

$$I_d = (V_d - V_{bd})/R_s + (V_{bias} - V_d)/R_q$$

One cell

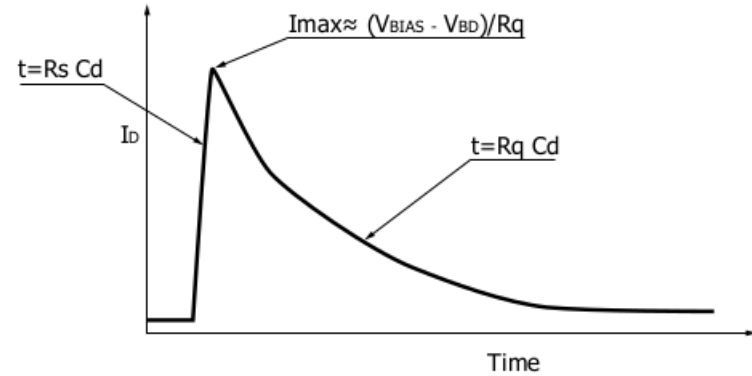

KAPDC0074EA

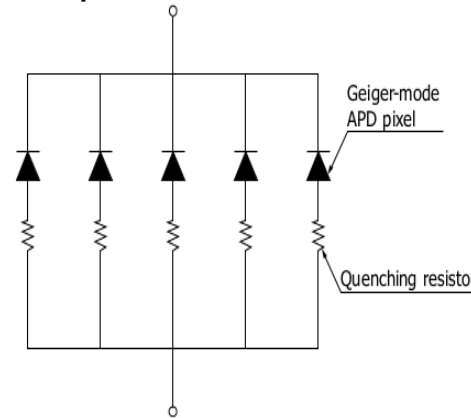

Many cells in parallel

KAPDC0029EA

KAPDC0073EA

Silicon Photomultipliers close-up

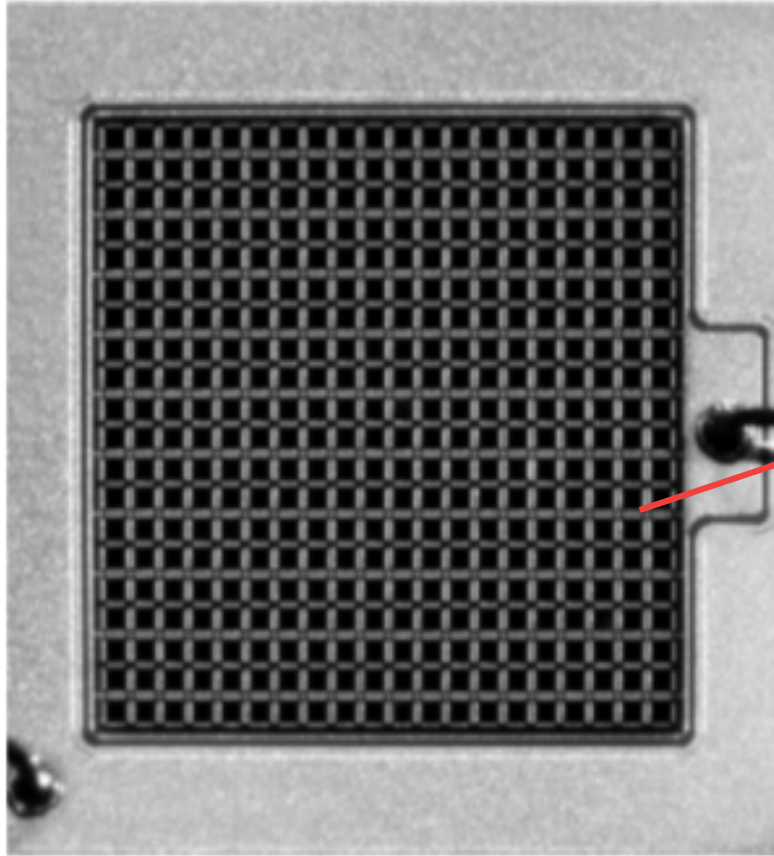

(a) Pixel pitch: 25 μm

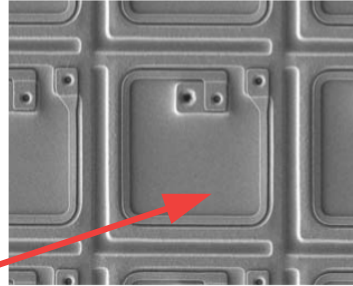

(b) Pixel pitch: 50 μm

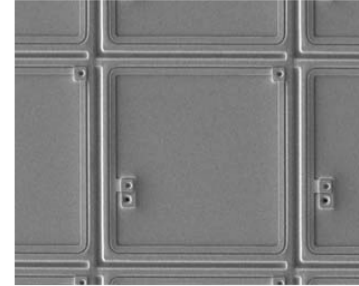

(c) Pixel pitch: 75 μm

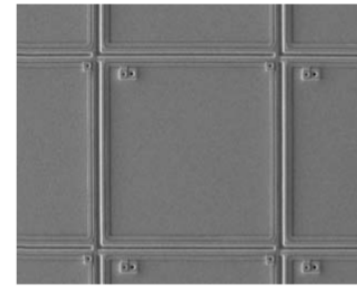

Individual cells

Gain and Photon Detection Efficiency

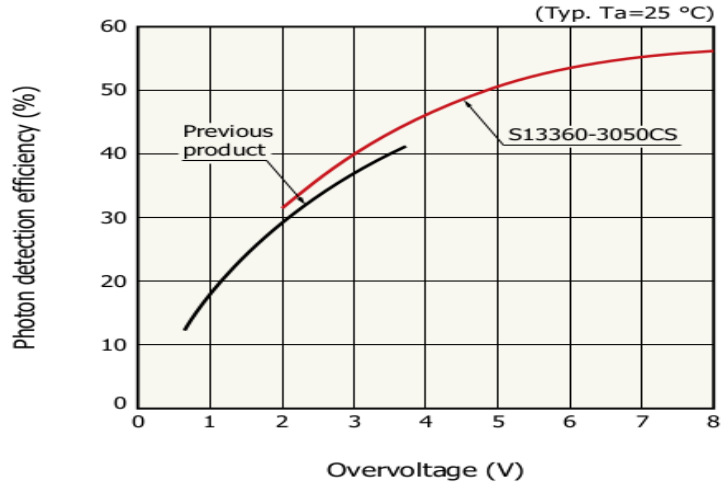

KAPDB0308EB

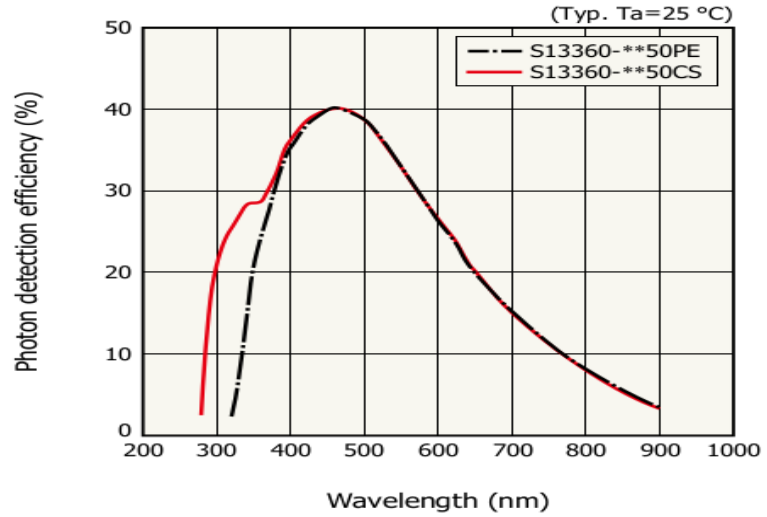

KAPDB0322EA

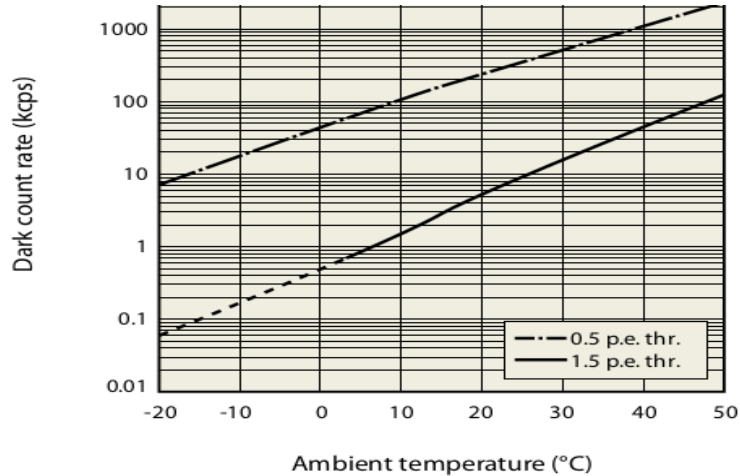

KAPDB0141EB

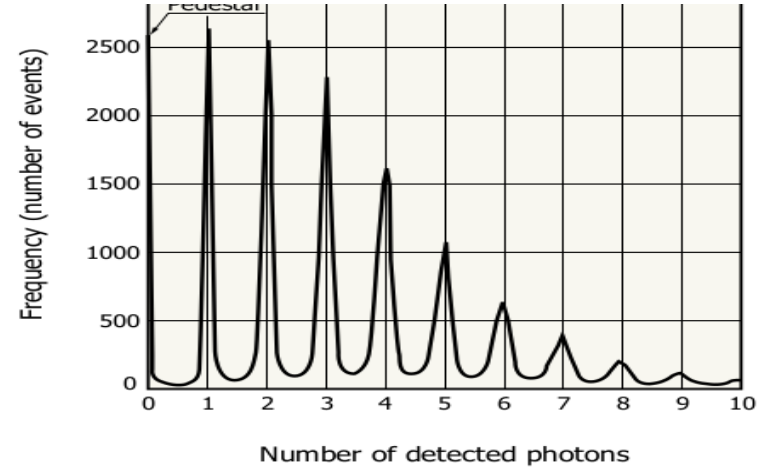

KAPDB0133EA

Cross talk and afterpulses

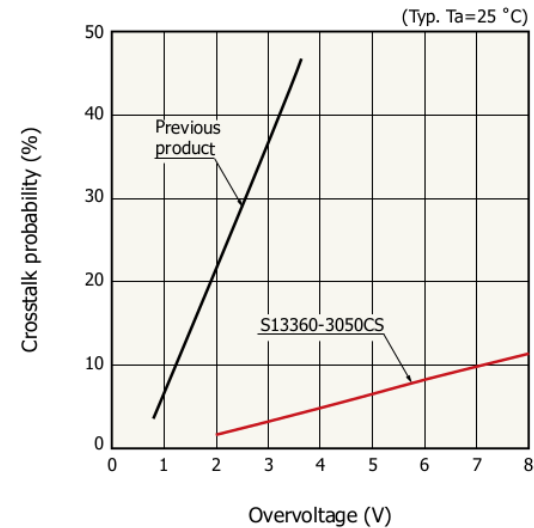
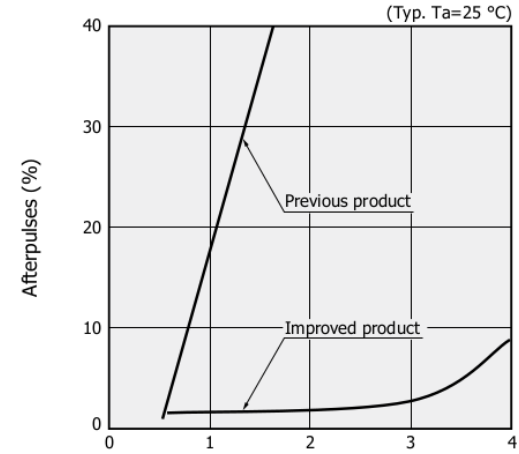
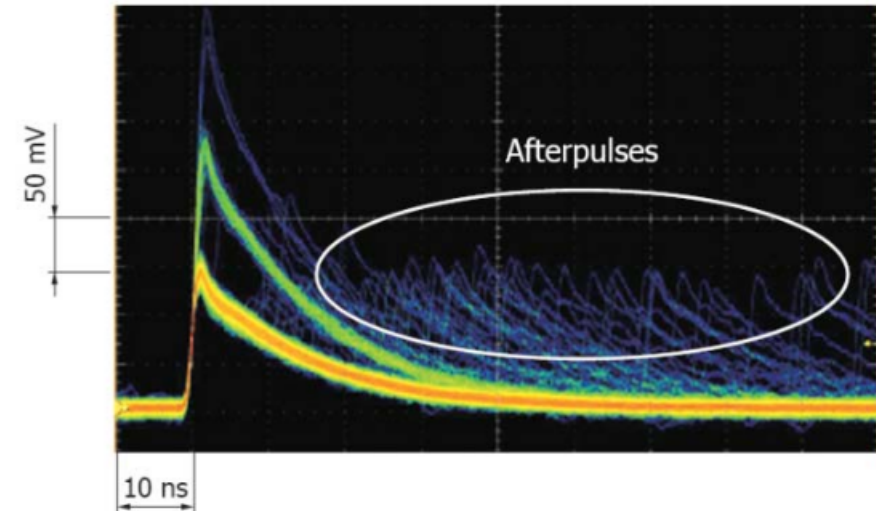
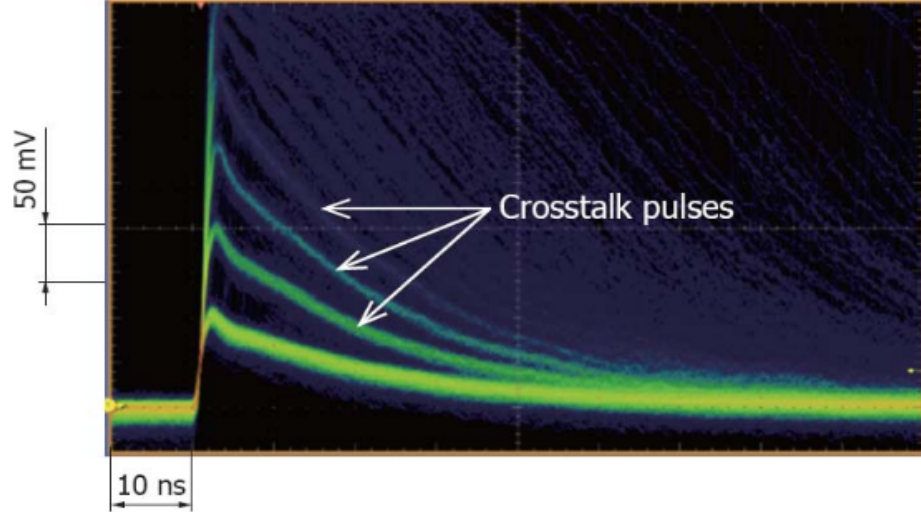

Silicon Photomultipliers - ganging

Excellent devices:

- *Low bias voltage O(50 Volt)*
- *Digital detectors*
- *High gain → Single Photo electron reconstruction capability*
- *Small amount of mass*
- *But small active area O(1 cm²) each*
- *Need of ganging schemes to reach the coverage of a standard PMT*
- *and/or coupling with passive photon collectors*

Example: DUNE single phase photon detection system

- *DUNE SP PDS profits both of SiPM (active) ganging and of a powerful passive collector*
- *48 6x6 mm² SiPM are ganged together and read-out by one single signal*
- *Two different designs developed (one at FNAL and one in Paraguay)*

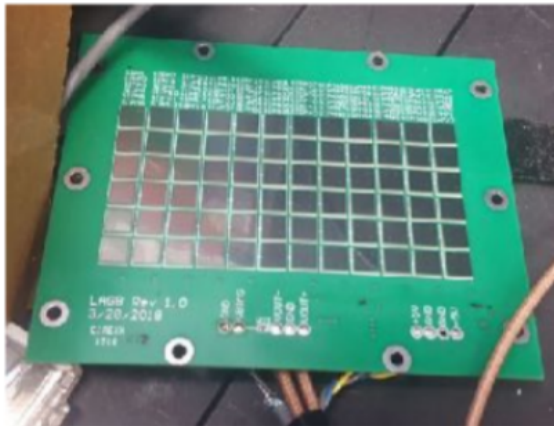
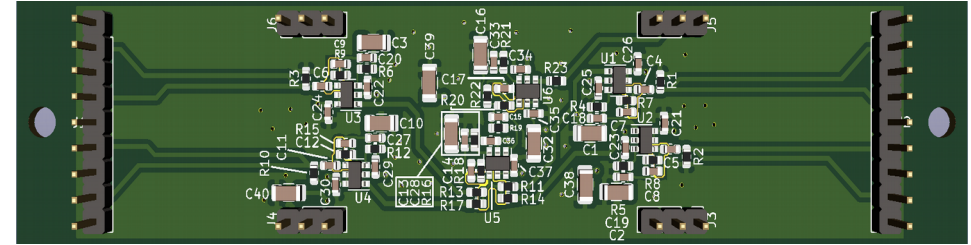

Gustavo's board

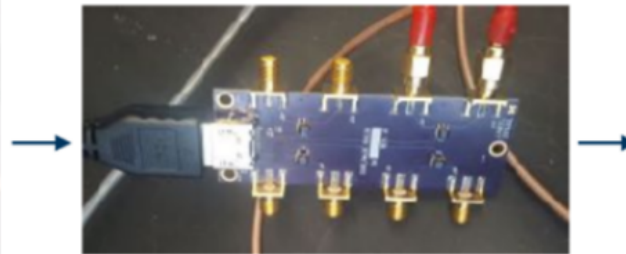

balun from Michigan



FEB

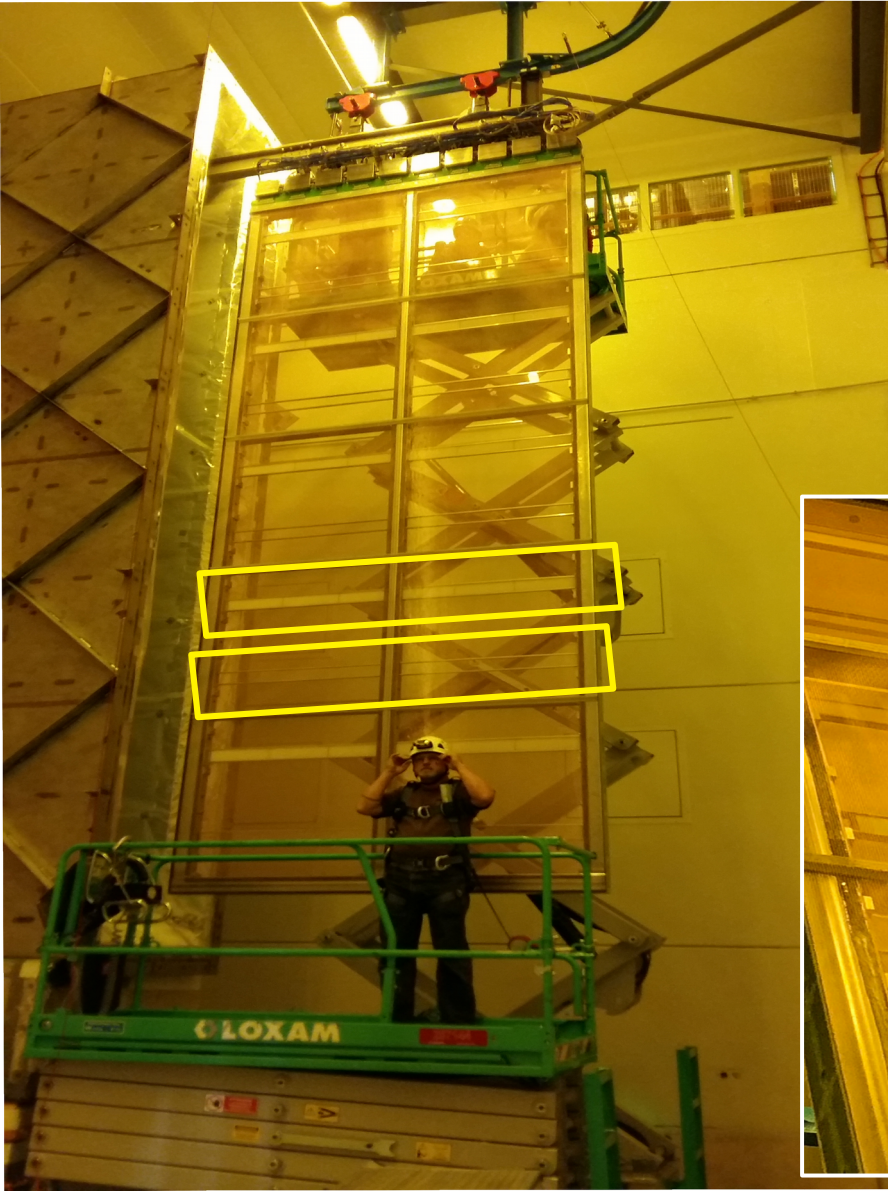

- The final design of the SP PD will appear very similar to the protoDUNE one:
- **Bar shaped modules** slid inside the APA frame between wire planes
- Each photon collector module will have approximate linear dimensions of 200 cm x 10 cm
- 10 modules per APA

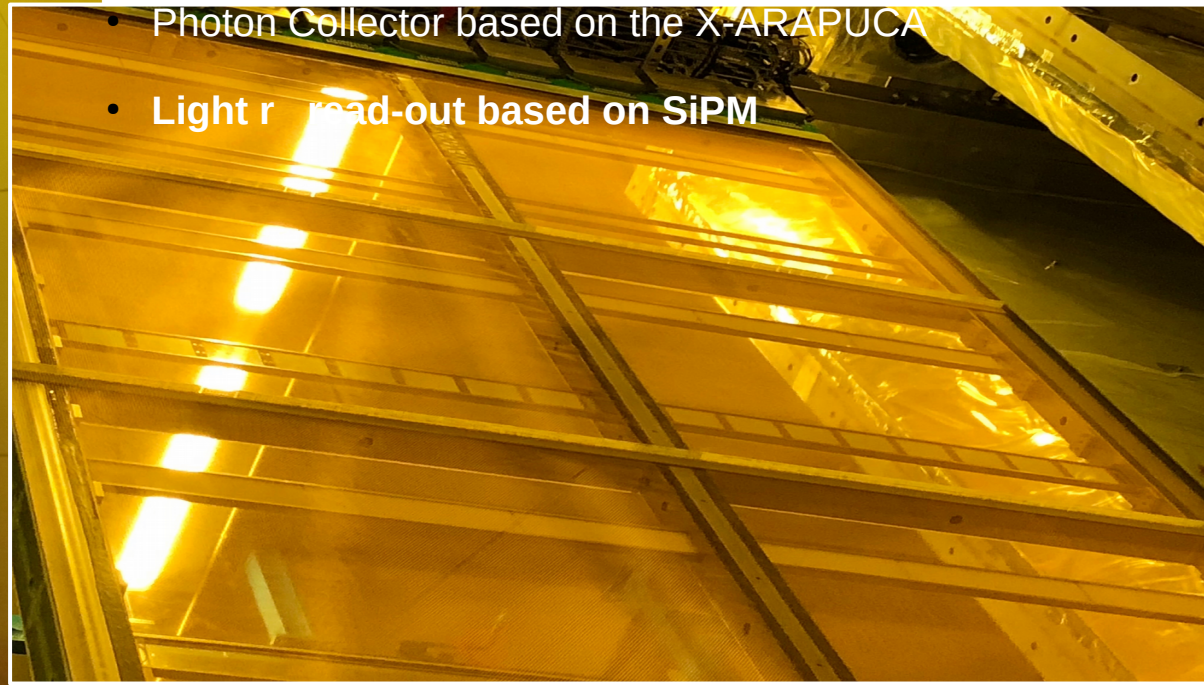

- Photon Collector based on the X-ARAPUCA
- Light read-out based on SiPM

ARAPUCA concept

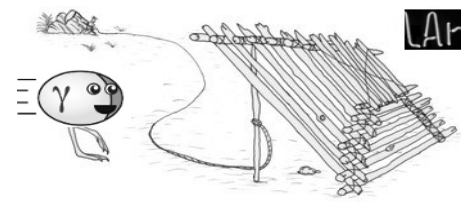

- **ARAPUCA** in the language of *native Brazilian* means **trap** for birds
- The idea is to **trap photons** inside a **box with highly reflective internal surfaces**, so that the detection efficiency of trapped photons is high even with a limited active coverage of its internal surface → Allows to reduce the number of active device and electronic channels.
- Detection efficiency can be tuned by varying the number of SiPMs (ratio between acceptance window and SiPM areas).
- LAr tests performed at **Fermilab** and in **Brazil** demonstrated a detection efficiency at the 1% level. ProtoDUNE design, with an increased number of SiPM is expected to be in the range of 2% to 3%. See F. Cavanna talk.
- DUNE design, based on **X-ARAPUCA** is expected to do better than this.

Dichroic filter

- The core of the device is a **dichroic filter**. It is a dielectric interference **film** deposited on a fused silica substrate.
- It has the property of being **highly transparent** for wavelength **below a cutoff** and **highly reflective above it**.

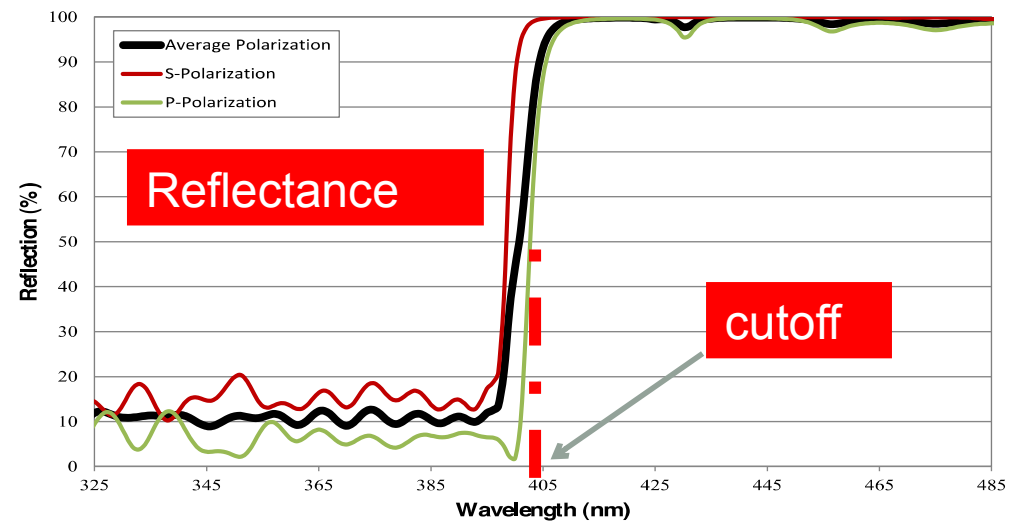
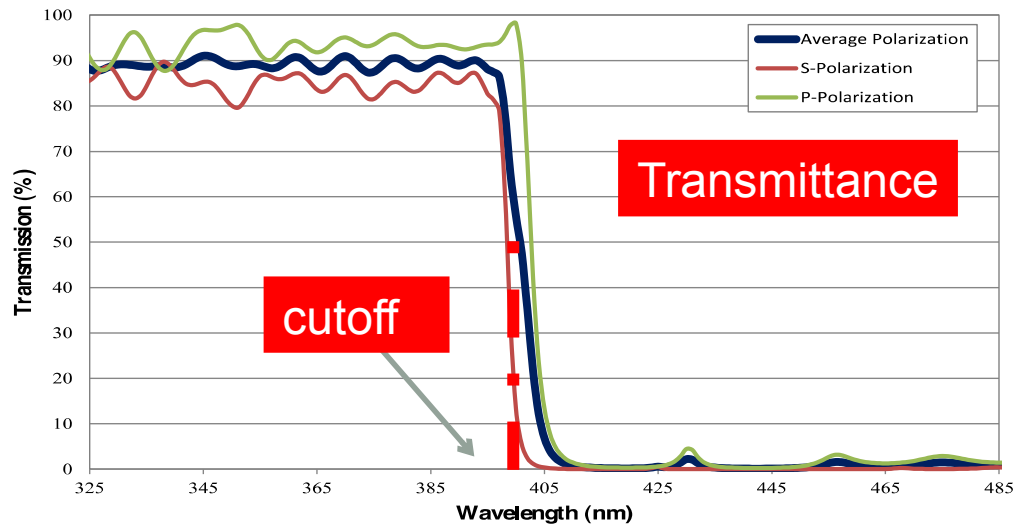

Operating principle

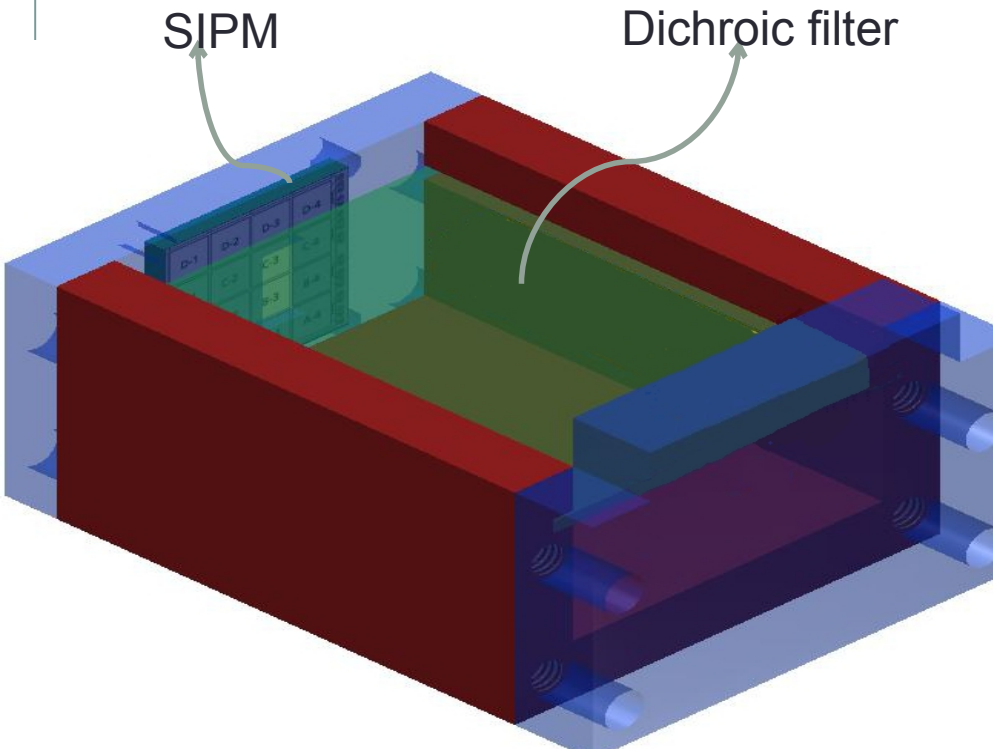

- The simplest geometry is a **flattened box** with highly reflective internal surfaces (Teflon, VIKUITI, VM2000) with an open side.
- The open side hosts the **dichroic filter** that is the acceptance window of the device
- The filter is deposited with **TWO WAVELENGTH SHIFTERS (WLS)** – one on each side
- The shifter on the **external side**, S1, converts LAr scintillation light (128 nm) to a wavelength L1, with **$L1 < \text{cutoff}$**
- The shifter on the **internal side**, S2, converts S1 shifted photons to a wavelength L2, **with $L2 > \text{cutoff}$**
- **The internal surface** of the ARAPUCA is observed by **one or more SiPM**

The Operating Principle cont.

- After the **first shift** the light enters the ARAPUCA since **the filter is transparent**
- After the **second shift** the **photon gets trapped inside the box** because the filter turns to be **reflective**
- Photons are **detected by the SiPM** after some reflections

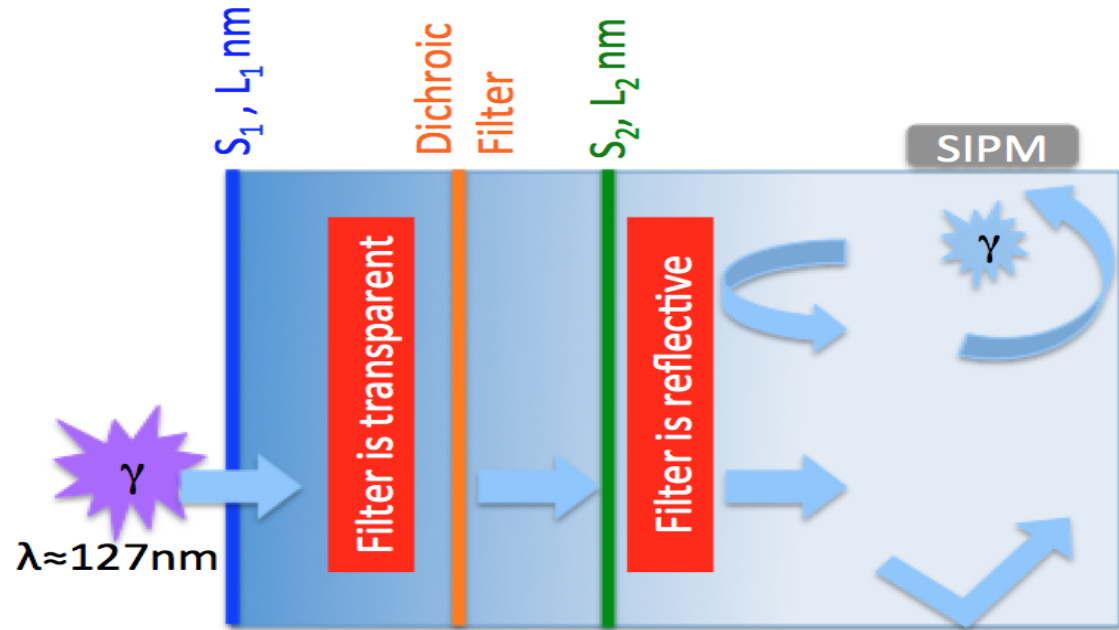

ARAPUCA modules in protoDUNE

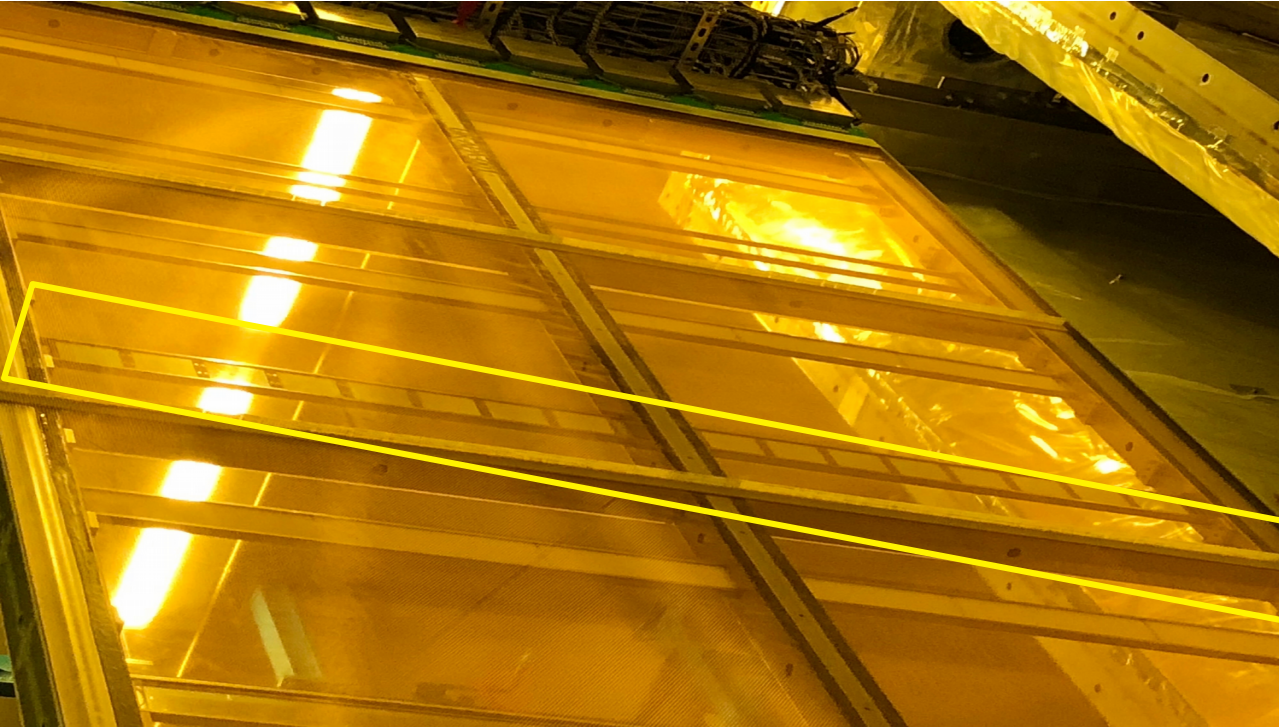

Two ARAPUCA arrays installed in protoDUNE (**APA#3** – close to the beam and **APA#4** -opposite side)

Each array hosts **16 ARAPUCA cells** (10 cm x 8 cm) and each cell is read-out by 12 (6) Hamamatsu SiPM passively ganged together.

*ProtoDUNE ARAPUCA array
assembled by CSU group*



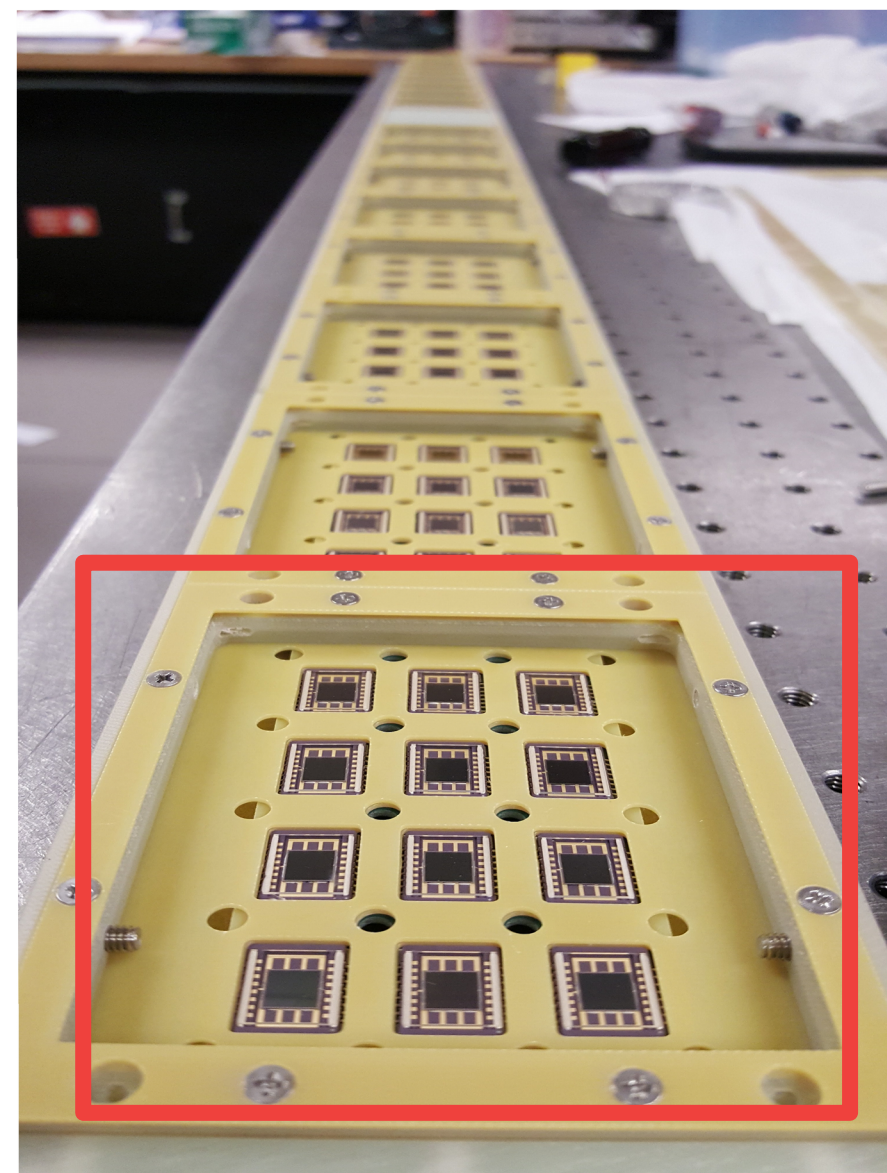

- Each cell is lined with **VIKUITI reflective** foils properly cut (*reflectivity > 98%*) - coated with a thin **TetraPhenyl-Butadiene** film (*TPB - emission wavelength 430 nm*)
- Acceptance window is a dichroic filter with **cut-off at 400 nm**
- Filters coated externally with **p-TerPhenyl** (*pTPemission wavelength 350 nm*)
- *ProtoDUNE ARAPUCAs are working !!!*
- ProtoDUNE represents an important part of the **ARAPUCA R&D** program

X-ARAPUCA concept

- The **X-ARAPUCA** represents a development and an optimization of the traditional *ARAPUCA*
- X-ARAPUCA is a *hybrid solution* between an ARAPUCA and a **light guide**
- In an X-ARAPUCA the inner shifter is substituted by an **acrylic slab** which has the *WLS compound embedded*. The active photo-sensors are optically coupled to one or more ends of the slab itself

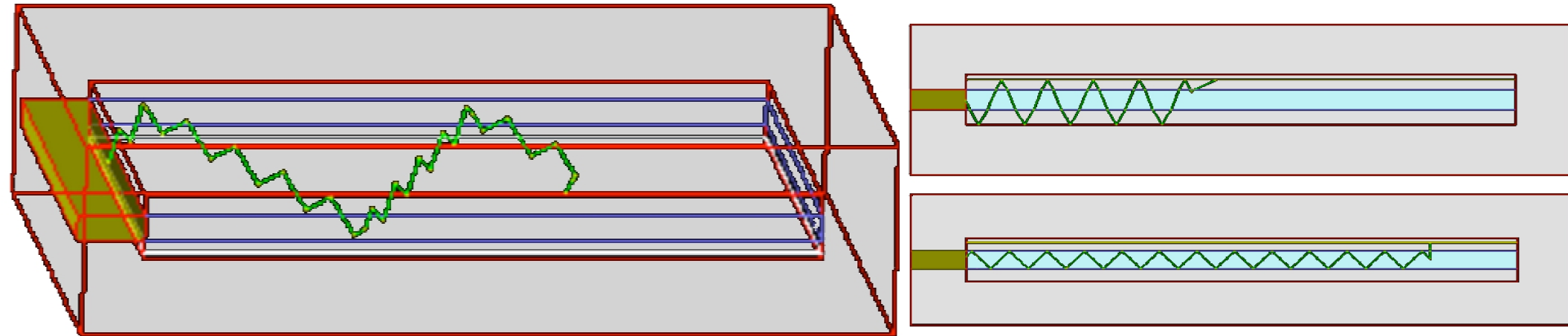

X-ARAPUCA concept

- There are *two main mechanisms* through which a photon can be detected by the X-ARAPUCA:
 - **Standard ARAPUCA mechanism.** The photon, after entering the X-ARAPUCA box, is converted by the WLS of the inner slab, but is not captured by total internal reflection. In this case the photon bounces a few times on the inner surfaces of the box until when it is or detected or absorbed;
 - **Total internal reflection.** The photon, converted by the filter and the slab, *gets trapped by total internal reflection*. It will be guided towards one end of the slab where it will be eventually detected. This represents an improvement with respect to a conventional ARAPUCA, which contributes to *reduce the effective number of reflections on the internal surfaces*. The sides of the slab where there are not active photo-sensors will be coated with a **reflective layer** which will allow to keep the photon trapped by total internal reflection.

X-ARAPUCA vs. ARAPUCA

- **X-ARAPUCA is more efficient in trapping photons:**
 - ✓ Analytical calculations and MC simulations appoint to an enhancement *between 40% and 70%* wrt ARAPUCA
- **Simpler design:**
 - ✓ **No need of evaporating** the internal side of the filter or internal surfaces
 - ✓ Great advantage especially for double sided X-ARAPUCAs
 - ✓ Faster production
- **Risk reduction:**
 - ✓ Reduced adhesion issues → limited to the external shifter

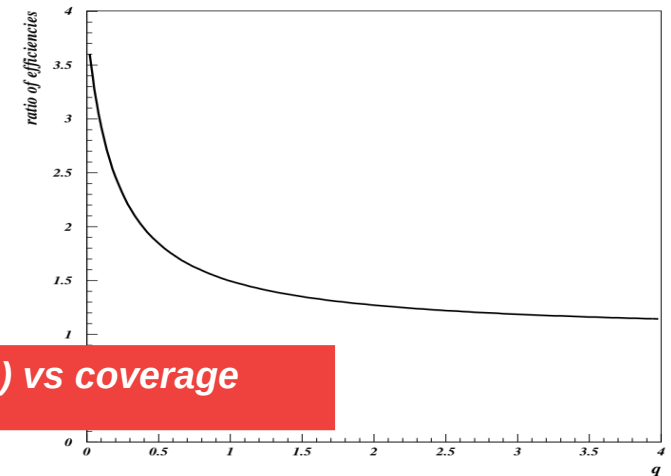
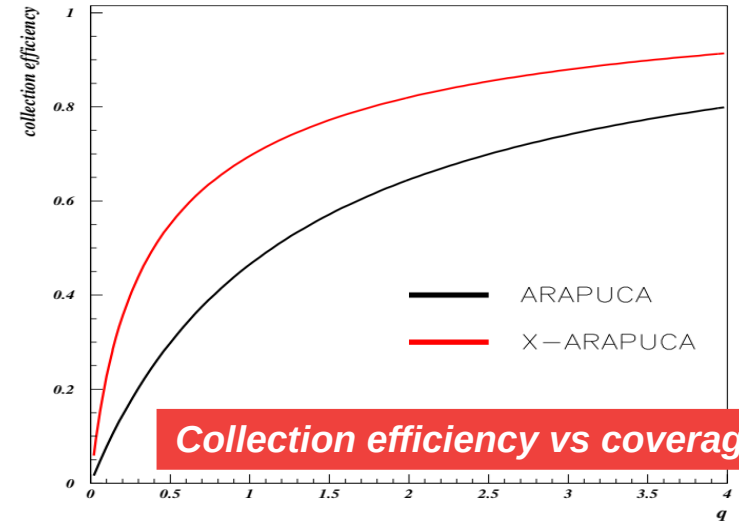

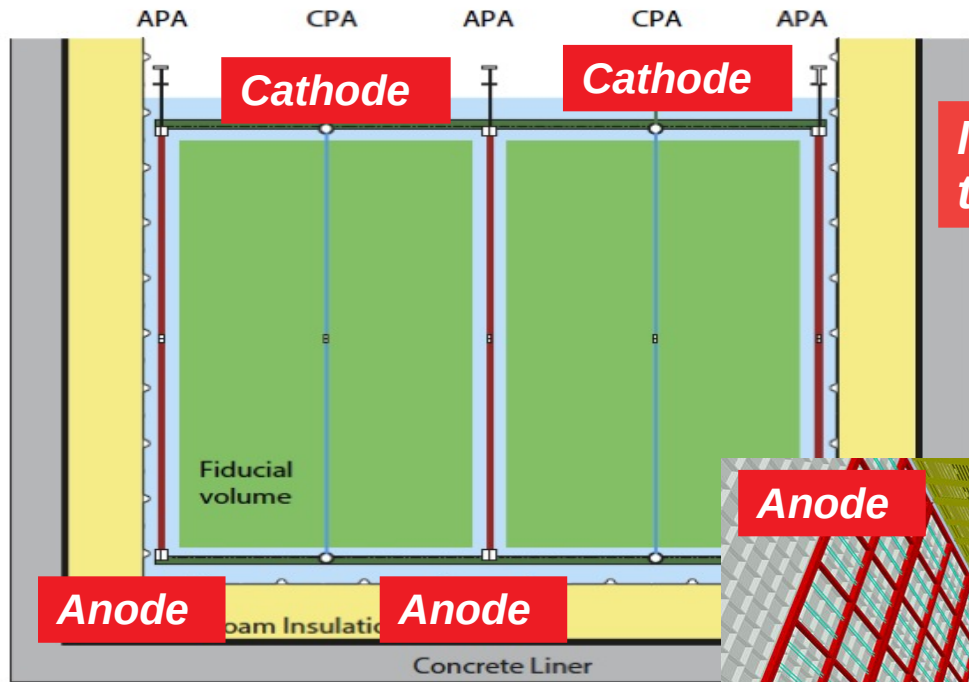

Modules installed on the central APAs need to be sensitive on two sides

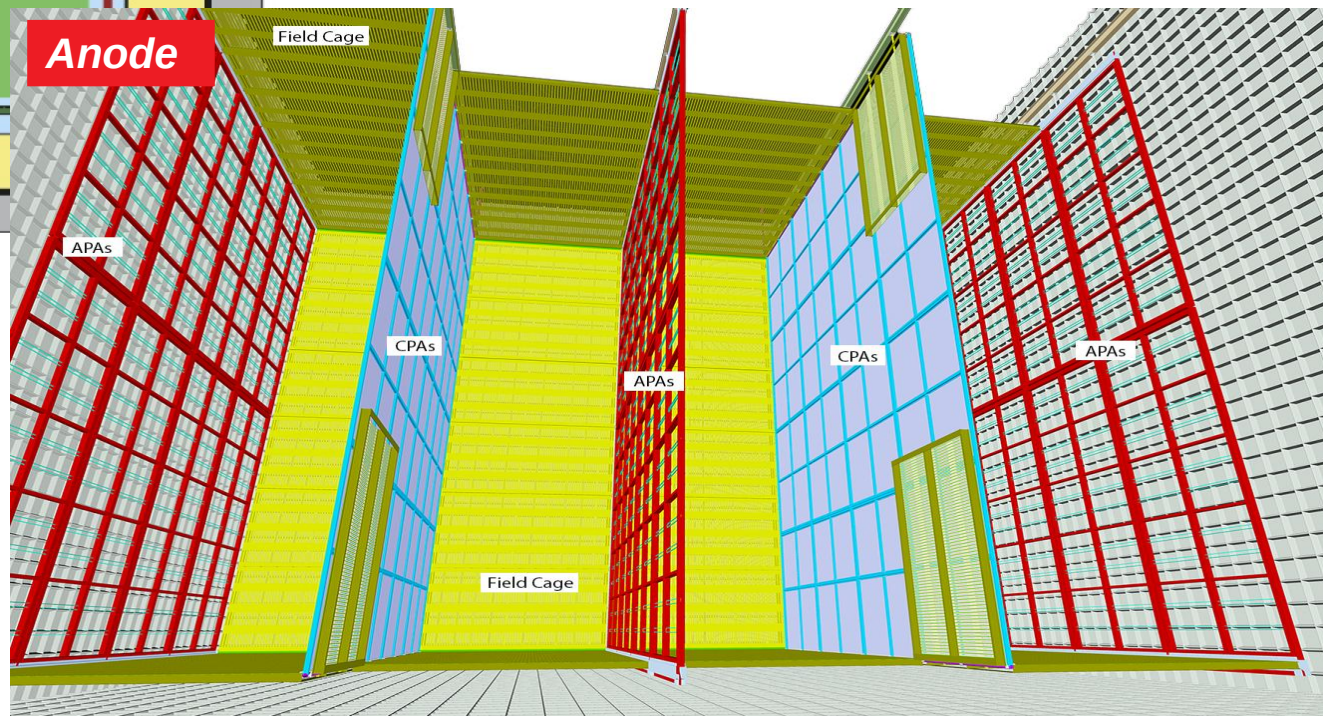

X-ARAPUCA R&D program

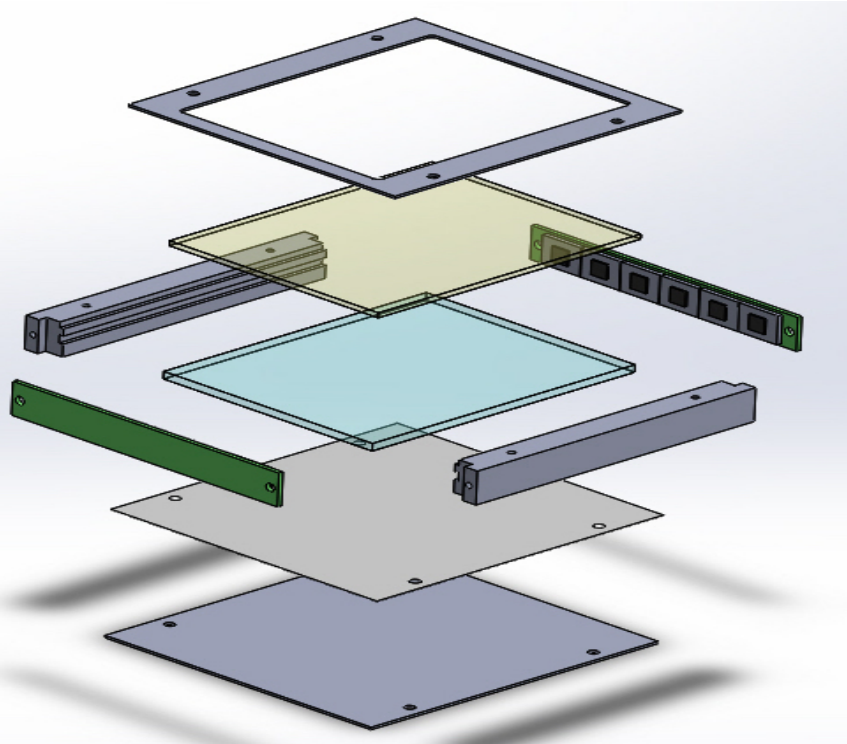

Model of the X-ARAPUCA to be tested at UNICAMP

Two tests will happen on the short term (before the end of 2018):

- A small 10 cm x 8 cm X-ARAPUCA will be tested in LAr at **UNICAMP**
- **X-ARAPUCAs supercells** (basic unit of DUNE design) will be tested in the **ICEBERG** set-up at Fermilab (*joint test with Cold Electronics Consortium*)
- Main objectives of the tests are measuring *the X-ARAPUCA detection efficiency* (and comparing with MC expectations), *studying interferences with CE*, *test of the active ganging and read-out electronics*

X-ARPUCA design

- An **X-ARAPUCA module** for DUNE will have dimensions of approximately 210 cm x 12 cm, segmented into *four cells (supercells)*. Each supercell is an X-ARAPUCA and will host **48 SiPMs** read-out by one single electronic channel
- We expect for these X-ARAPUCAs a detection efficiency *larger than 3%* (on the basis on analytical calculations, MC simulations and experimental tests). *Physics requirements should be (largely) met with such level of efficiency.*
- This result is outstanding, since large area (8") PMTs coated with wavelength shifter (TetraPhenyl Butadiene – TPB) are typically in the range of 5% - 7% in total detection efficiency. An X-ARAPUCA module is equivalent to **~3 large area PMTs**
- X-ARAPUCA design is expected to be >10 times more efficient than the most efficient light-guide bar installed in protoDUNE

Photosensors

- Current baseline is **Hamamatsu MPPC**
- **Two models** are being systematically investigated:
 - *S13360-6050VE*: 6x6mm MPPC with 50um pixel and *epoxy resin coating* in SMD package w/ TSV terminal
 - *S13360-6050CQ*: Uncoated 6x6mm MPPC with 50um pixel in ceramic package with *quartz window*
- Both sensors have been installed in protoDUNE: *S13360-6050CQ* on ARAPUCA modules and *S13360-6050VE* on a fraction of the guiding bars
- ***Both models resulted to be adequate to work at LAr temperature.*** *S13360-6050VE* is our preferred option because of its *smaller packaging* which fits better into the X-ARAPUCA design where sensor are mounted on ***the lateral surface of the box.*** They are cheaper.
- A sample of 400 units of *S13360-6050VE* was purchased a few months ago. It is undergoing an extensive series of tests at NIU and CSU in order to characterize their behavior at room and cryogenic temperature

Electronics – Cold active ganging

Read out electronic is divided into **two stages**: *Cold active ganging board* and *digitizing board*

- **Cold ganging (summing) board:**

- SiPMs are small devices. They need to be ganged in order to contain the number of read-out channels. There is a limitation on the number of channels per ARAPUCA bar due to the space available to route the cables inside APA (see D. Warner talk). **There will be 4 readout channels per module** → *one channel per X-ARAPUCA supercell*.
- **48 SiPMs will be ganged together**. The ganging is active, that is using active components (Operational Amplifier)
- The active ganging board is installed on the X-ARAPUCA module and *operates at LAr temperature*
- *Two active ganging circuits developed by the Consortium*. With different degrees of maturity at this moment. Both **demonstrated LAr operation** and single photo-electron resolution

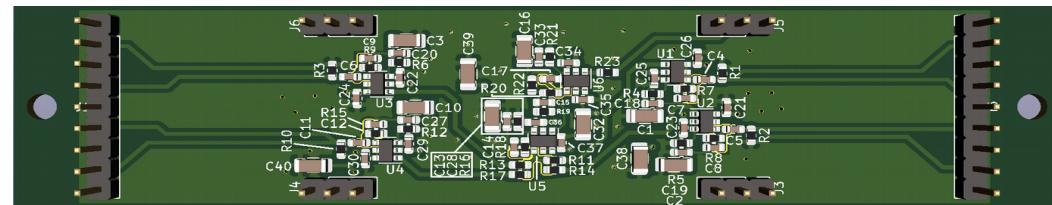

Electronics – Digitizing board

Digitizing board:

- It receives the signals from the ganged SiPM, performs digitization and communicates with the DAQ;
- Baseline design based on a commercial chip used for medical applications (board originally developed for the veto system of the *Mu2e experiment*). *Cost/channel very favorable*;
- A second design is being developed in **Latin America** (Colombia and Brazil). *Integration of the ganged signal followed by a (slow) digitization to detect the peak of the integrated signal.*

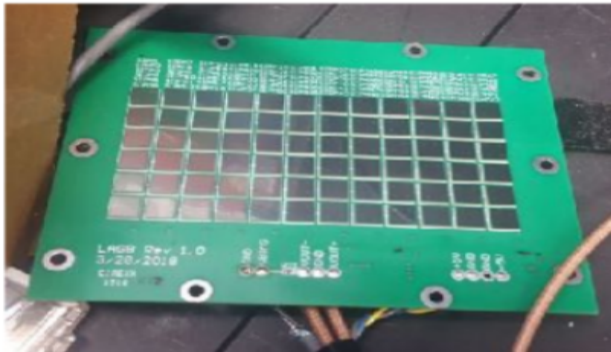

Gustavo's board

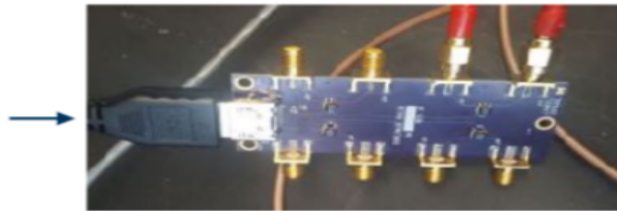

balun from Michigan

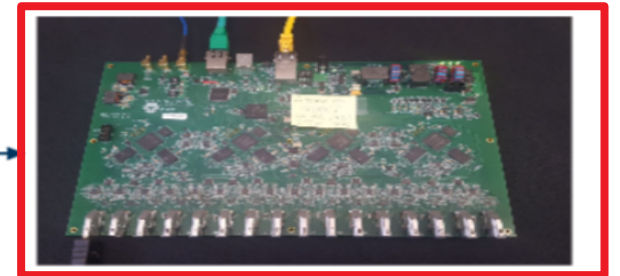

FEB

Options

- Consortium is investigating **two options** which can improve the performance of the PDS and *add features*, such as the **uniformity** in light collection, which are desirable for some of the **Physics goals** of the system (calorimetric measurements)
- Light collection suffers of huge non-uniformity for events near the anode (where the PD modules are located) with respect to those near the cathode, because of the **Rayleigh scattering length of LAr** scintillation light ($\lambda = 128 \text{ nm}$; $L_{\text{Rayleigh}} \sim 60 \text{ cm} - 90 \text{ cm}$)
- *The two options are:*
 - *Installing reflective foils coated with wavelength shifter on the cathode*
 - *Doping LAr with Xenon*
- They add similar benefits but **are not 100% overlapped**

Shifting/reflective foils

- Reflective foils coated with *WLS* are installed on the cathode
- Technique widely used in the past by **Dark Matter experiments** and in **LArIAT experiment**
- Approved for the **SBND experiment**

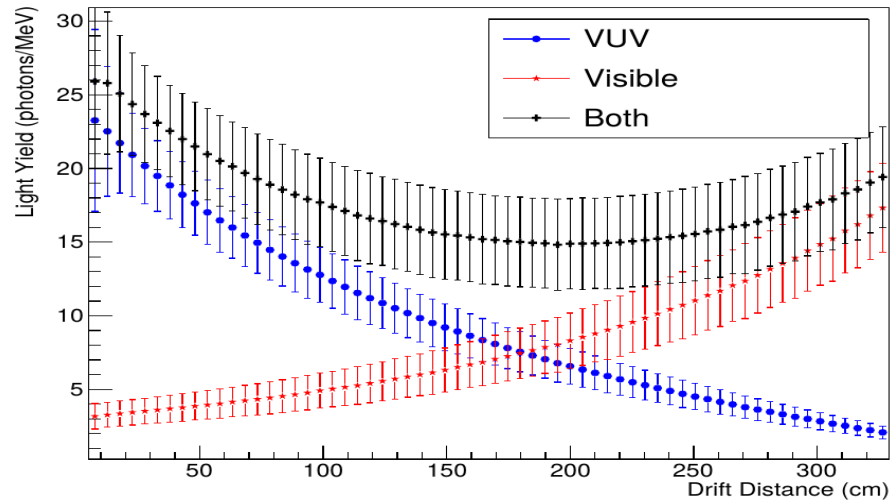
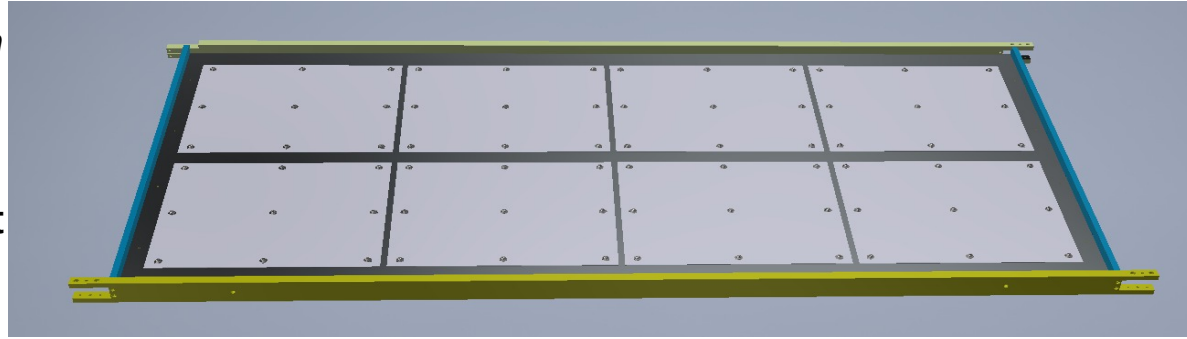

- Great improvements in the **uniformity of light collection**
- *Improvement in light yield*
- *Potentially enable x-position (drift direction) resolution with light*

Xe Doping

- Concentrations of the order of tens of ppm of Xe in LAr allow to shift the **128 nm** scintillation of LAr to **174 nm**
- ***Longer Rayleigh scattering length (6 times longer)***
- ***Triplet component*** of LAr scintillation light ***gets much shorter***: hundreds of ns instead of 1.5 μ s
- ***Uniformity significantly improves given the longer scattering length***
- **X-ARAPUCA design simplification:**
 - Potential to remove outer wavelength shifter from light collector modules (fused silica is transparent to 174 nm photons – Transmissivity ~ 80%)
 - *Increase Detection efficiency*
 - **Reduction of costs** for the production of PD modules
 - **No risk of light exposure of the PD modules. X-ARAPUCA would not have any evaporated film, nor externally neither internally**

ARAPUCA

passive collector

- Powerful collector, able to increase the effective SiPM coverage by a factor 5
- Developed in Brazil with the contribution of several Latin America and US groups.
- Current baseline design for the SP DUNE far detector
- Gain of a factor 10 wrt previous design
- See Ana's talk for all the details

ProtoDUNE ARAPUCA prototype before closure with filters

Latest ARAPUCA test at UNICAMP (X-ARAPUCA)



Two arrays of 4 HMMTS TSV MPPC

**LAB.
LEPTONS**

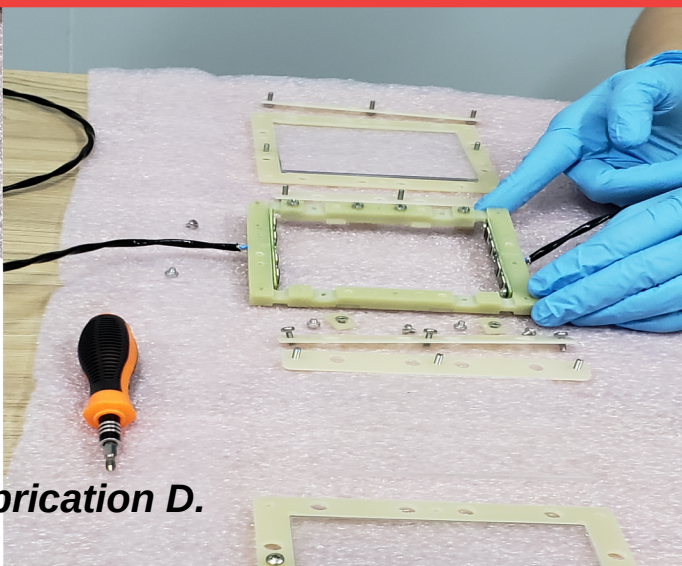

Design and fabrication D. Warner

**LAB.
LEPTONS**

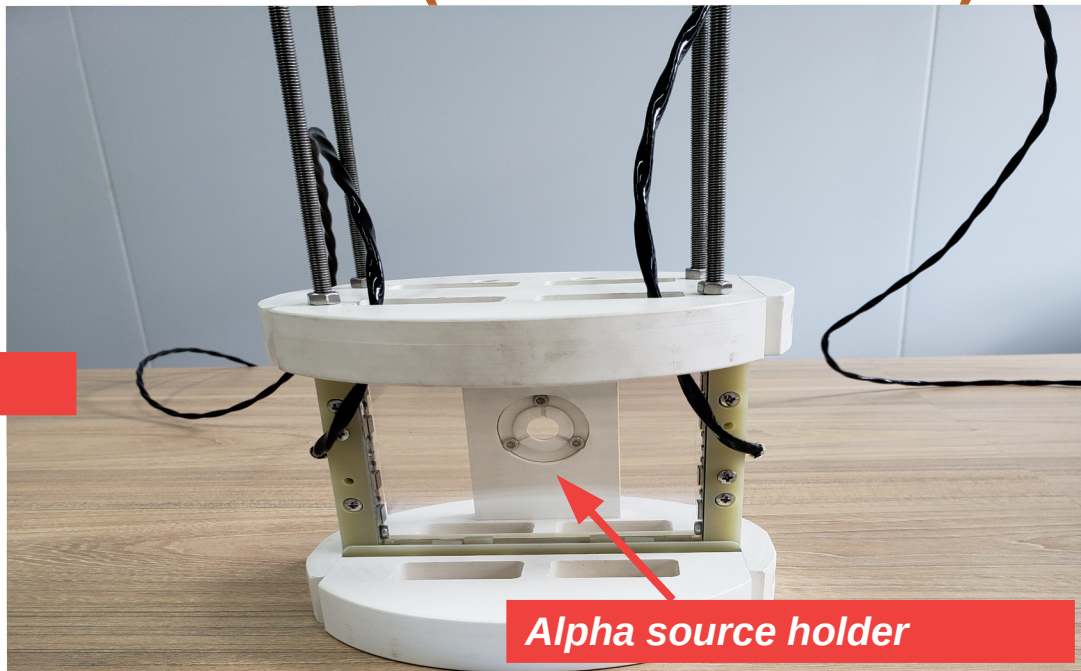

Alpha source holder

Supporting structure A. Machado, A. Pissolatti

**LAB.
LEPTONS**

Filters evaporation



Deep cleaning of the evaporator before using pTP

- Quality of the films is perfect
- Thickness around $400 \mu\text{g}/\text{cm}^2$
- Verified emission spectrum of pTP



Maria Cecilia Bazetto, Vinicius Pimentel, Henrique Souza, Jully Nascimento, Rafaela Ramos, Bruno Gelli, Greg de Souza

MC simulation

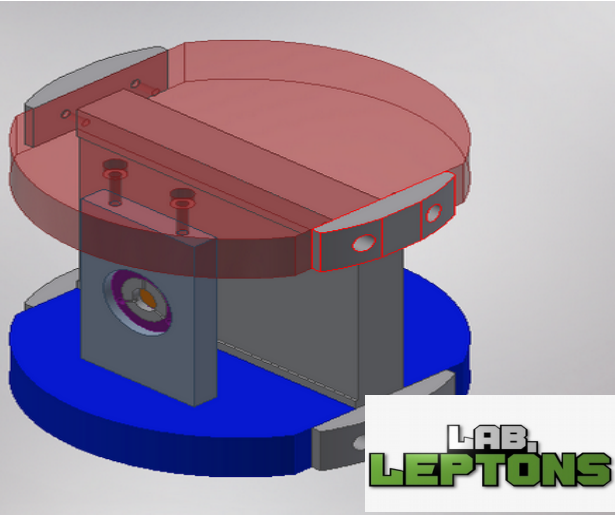

Alpha Spectrum

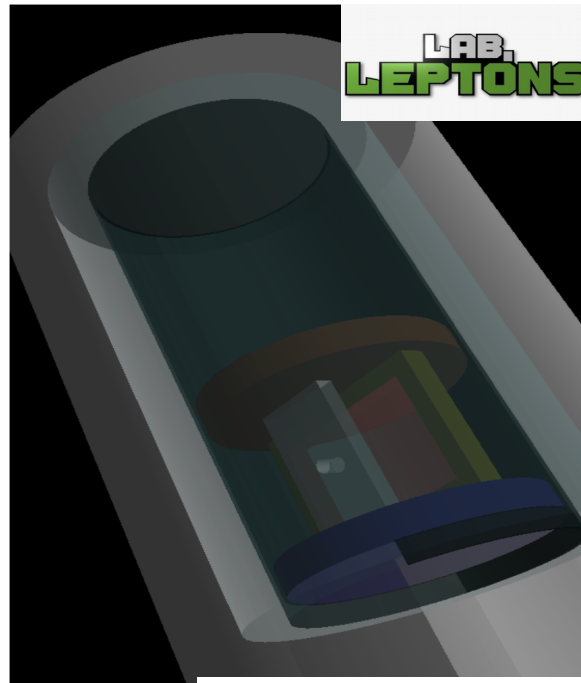
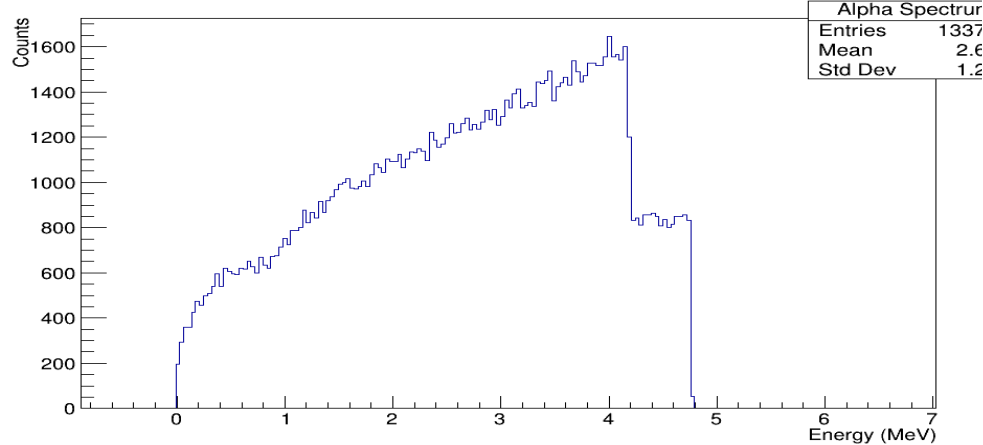

- G4 Monte Carlo Simulation
- Alpha source precisely simulated → natural uranium in an aluminum matrix
- Optical properties of the materials implemented
- The number of photons hitting X-ARAPUCA window will be extracted

photons/alpha

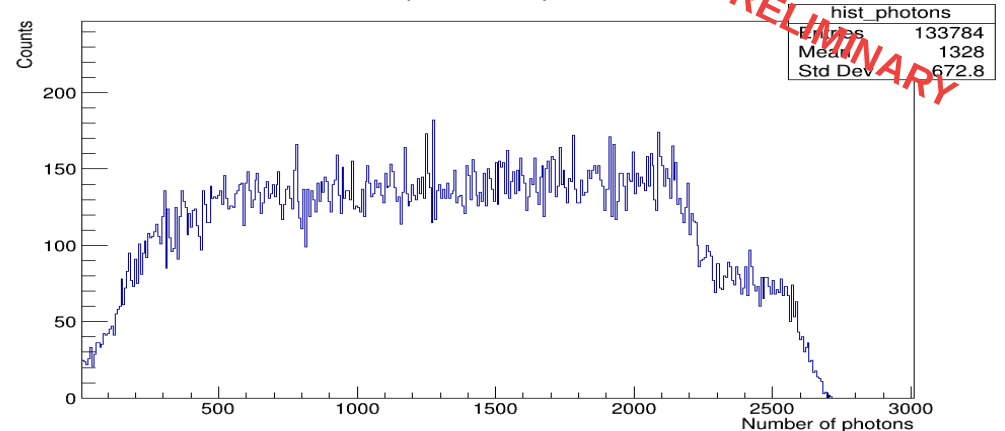

PRELIMINARY

Rafaela Ramos, Ana Machado, Bruno Gelli

Mechanics-cryogenics

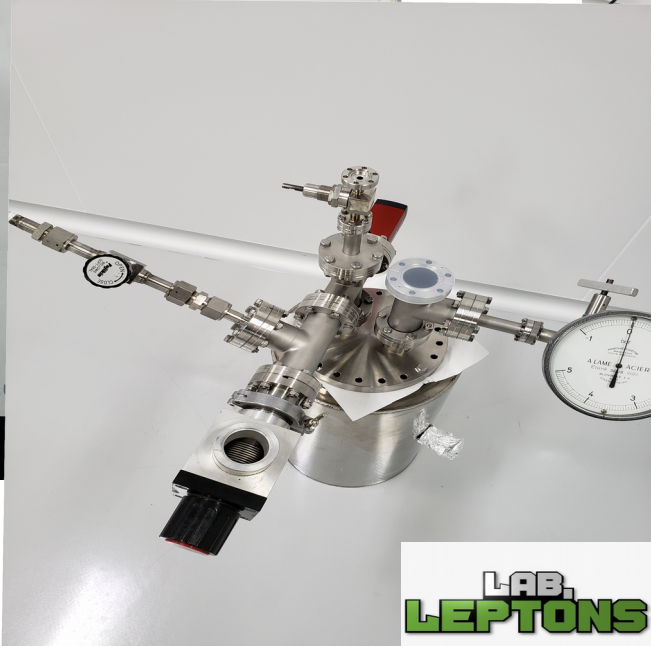
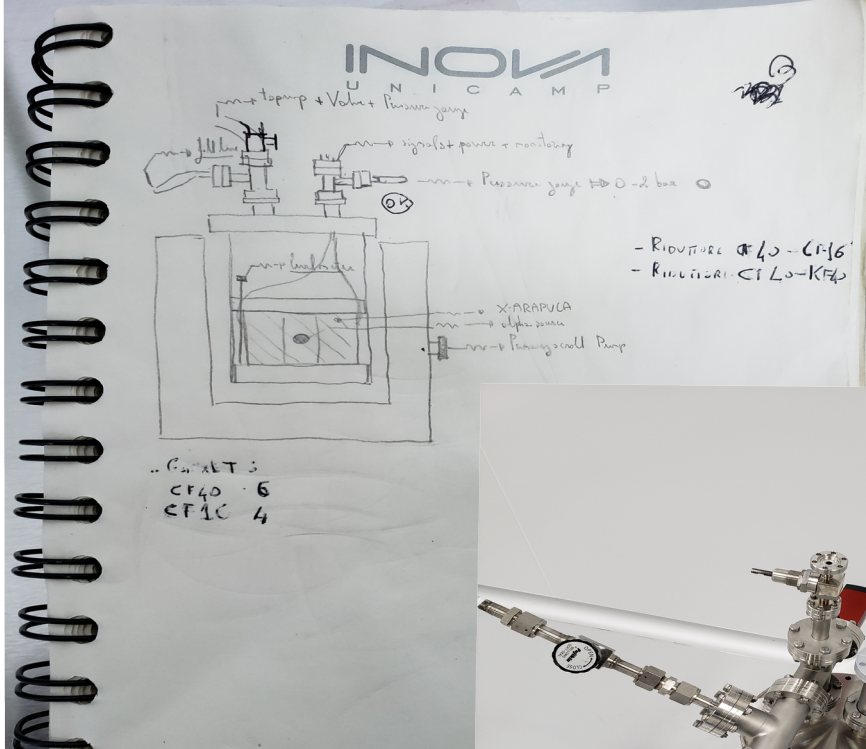

LAB.
LEPTONS

LAB.
LEPTONS

LAB.
LEPTONS

Our group keeps growing!



Light Yield of a scintillation detector

LY can be factorized as:

$$LY = N_{\gamma} \bullet \epsilon_{PSD} \bullet \epsilon_{opt}$$

Where:

- ✓ N_{γ} is the **photon yield** of the scintillator => number of photons produced per unit of deposited energy by a certain radiation
- ✓ ϵ_{PSD} is the **conversion efficiency of the PSDs** => the efficiency of the PSD system in converting photons into signal (photo-electrons)
- ✓ ϵ_{opt} is the **optical efficiency** => the fraction of the originally produced photons that

N_{γ} and ϵ_{PSD} in the majority of the cases are precisely known. On the other side ϵ_{opt} is typically unknown and needs to be estimated.

Recursivity of light propagation (think to a sphere...)

The propagation of photons inside a scintillation detector is an *intrinsically recursive process*.

Reflectivity = R

Optical window - photcatodic coverage = f

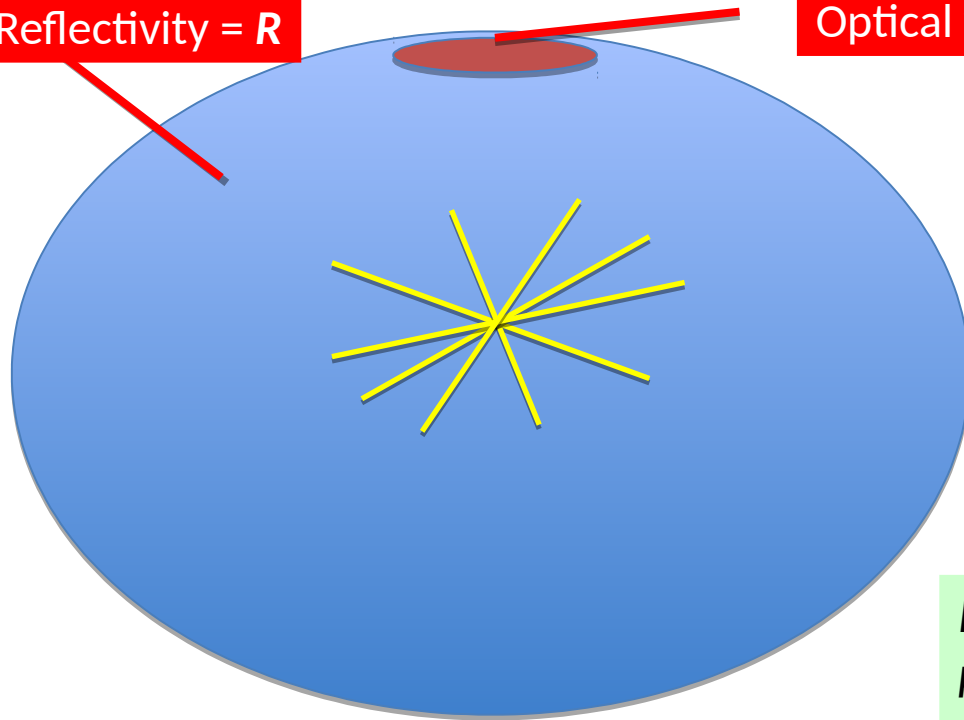

A photon produced in a **random point inside the sphere** with a **random direction** when reaches the boundary surface has an *average probability f to be detected*

And a probability $R(1-f)$ to be sent back into the chamber

Reflected photons has again a detection probability equal to f and a probability to be reflected equal to $R(1-f)$ when hit the boundary surface for the second time

The same situation will repeat again **identical to itself after any reflection.**

...let's generalize a little bit (I)

- Consider a **general scintillation detector** and assume that the **process is recursive**
- It can be divided into a series of subsequent and indistinguishable steps and it is possible to define two quantities:
 - ✓ α is the average probability per step that a photon is detected
 - ✓ β is the average probability per step that a photon is regenerated, that is the probability that it is not lost (detected or absorbed) and that some physical process randomizes again its direction (reflection for instance)
 - ✓ α and β are constant for all the steps (recursivity of the process)
 - ✓ $\alpha \leq 1$ and $\beta < 1$
- **Detection and regeneration probabilities after n steps are easily calculated:**

	detection probability	regeneration probability
step 0	α	β
step 1	$\alpha\beta$	β^2
step 2	$\alpha\beta^2$	β^3
...
step n	$\alpha\beta^n$	β^n

...let's generalize a little bit (II)

$$\varepsilon_{opt} = \sum \alpha \beta^n = \frac{\alpha}{1 - \beta}$$

For the *spherical scintillator* (and one can safely extend *to scintillators of regular shapes*) this means that:

$$\varepsilon_{opt} = \frac{f}{1 - R(1 - f)}$$

$$\alpha = f$$

$$\beta = R(1 - f)$$

If the optical window has *transmissivity* T_w and *reflectivity* R_w :

$$\varepsilon_{opt} = \frac{T_w f}{1 - R(1 - f) - R_w f}$$

$$\alpha = T_w f$$

$$\beta = R(1 - f) + R_w f$$

Including Rayleigh scattering and absorption

Define:
$$\frac{1}{\tilde{\lambda}} = \frac{1}{\lambda_R} + \frac{1}{\lambda_A}$$

λ_R -> Rayleigh scattering length
 λ_A -> absorption length

and:

$$U_{RA}$$

probability that a photon reaches the end of the step, as defined in absence of scattering/absorption, without interactions

It is possible to define:

$$\alpha = U_{RA} \alpha_0$$
$$\beta = U_{RA} \beta_0 + (1 - U_{RA}) \frac{\tilde{\lambda}}{\lambda_R}$$

Photon regenerated by reflections

Photon regenerated by scattering

with α_0 and β_0 detection and regeneration probabilities in absence of scattering and absorption

Including Rayleigh scattering and absorption (II)

After little algebra one finds:

$$\varepsilon_{opt} = \frac{\alpha_0}{Q - \beta_0}$$

α_0 and β_0 detection and regeneration probability in absence of scattering and absorption

With:
$$Q = \frac{1 - (1 - U_{RA}) \frac{\tilde{\lambda}}{\lambda_R}}{U_{RA}}$$

This factor takes into account **all the effects** of scattering and absorption

For our simple detector, under reasonable hypotheses, one obtains:

$$U_{RA} = \frac{\tilde{\lambda}}{\tilde{L}} (1 - e^{-\tilde{L}/\tilde{\lambda}}) \quad \text{with:} \quad \tilde{L} = 6 \frac{V}{S}$$

It is the characteristic linear dimension of the detector

Monte Carlo tests of the model

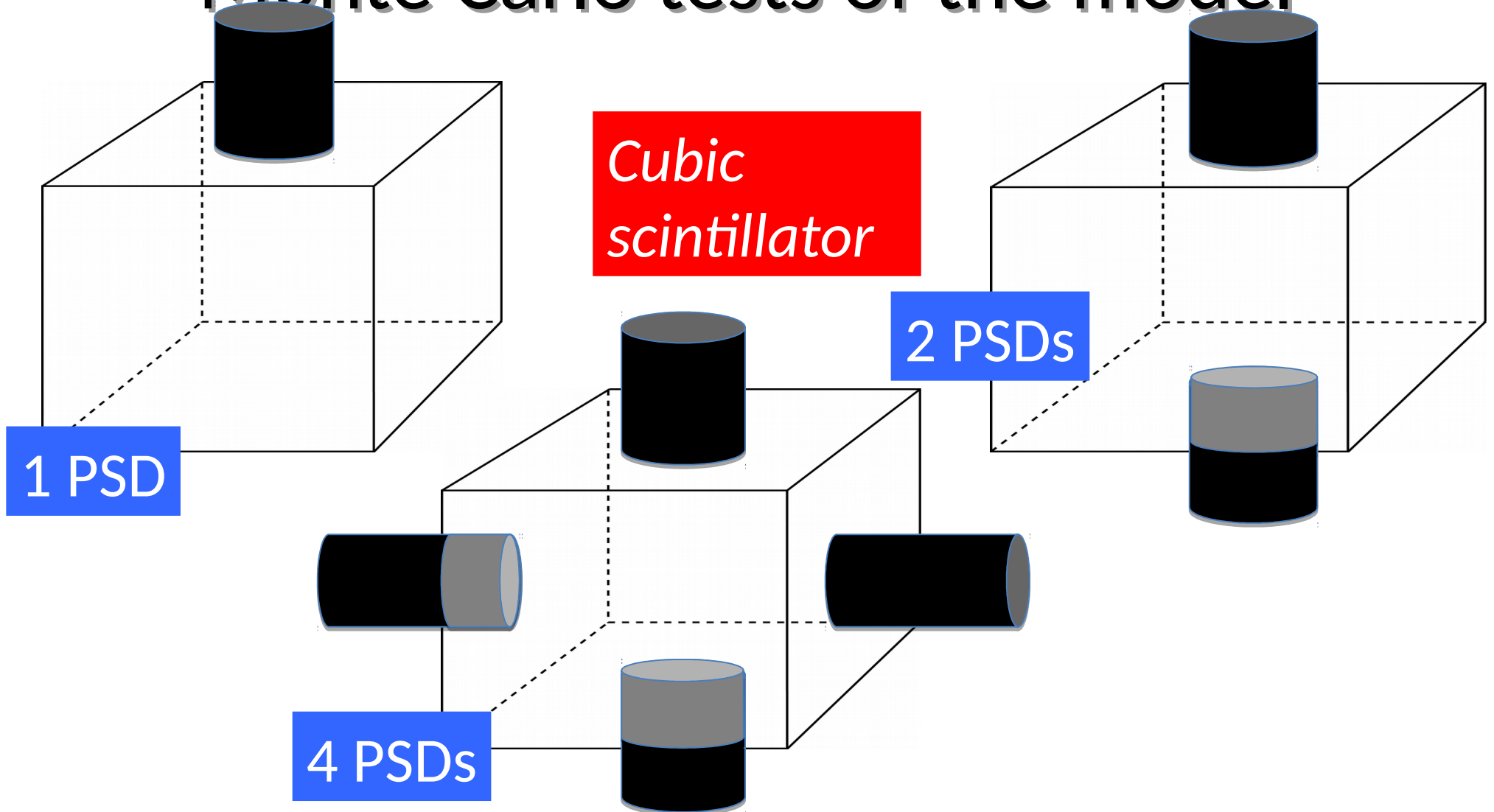

Monte Carlo tests of the model (II)

Specular reflectivity

Diffusive reflectivity

RED LINES :

$$\epsilon_{opt} = \frac{T_w f}{1 - R(1 - f) - R_w f}$$

1 PSD

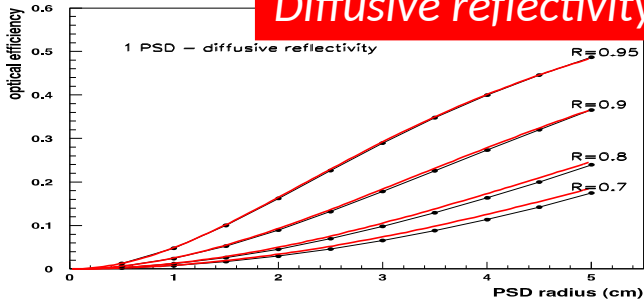
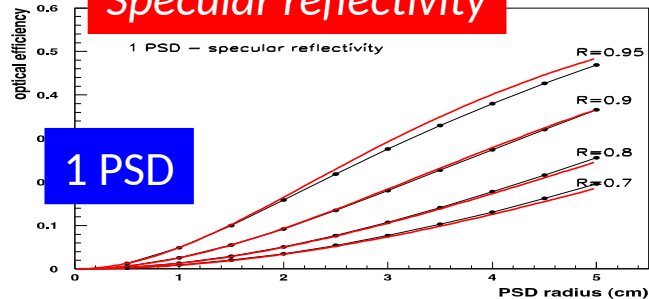

2 PSDs

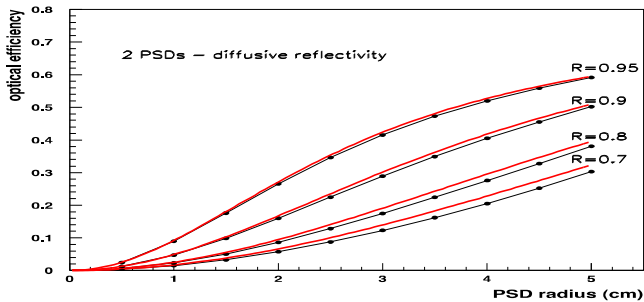
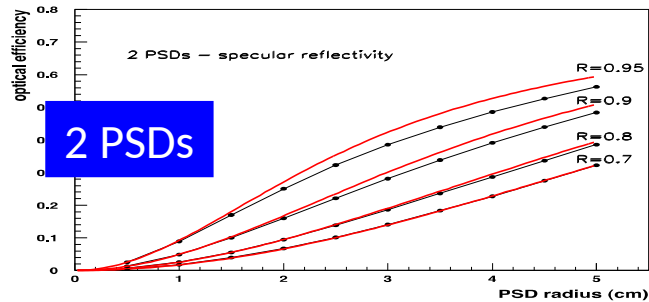

4 PSDs

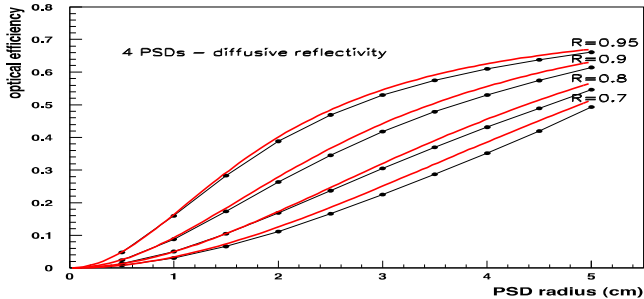
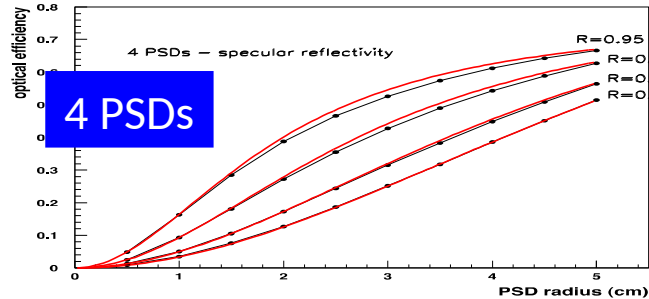

In the case of 2 (4) PSDs the formula is calculated with respect to one PSD. R is the average reflectivity of inactive surfaces and other PSDs' windows. The total efficiency is 2 (4) times the single PSD efficiency

Monte Carlo tests of the model (scattering and absorption)

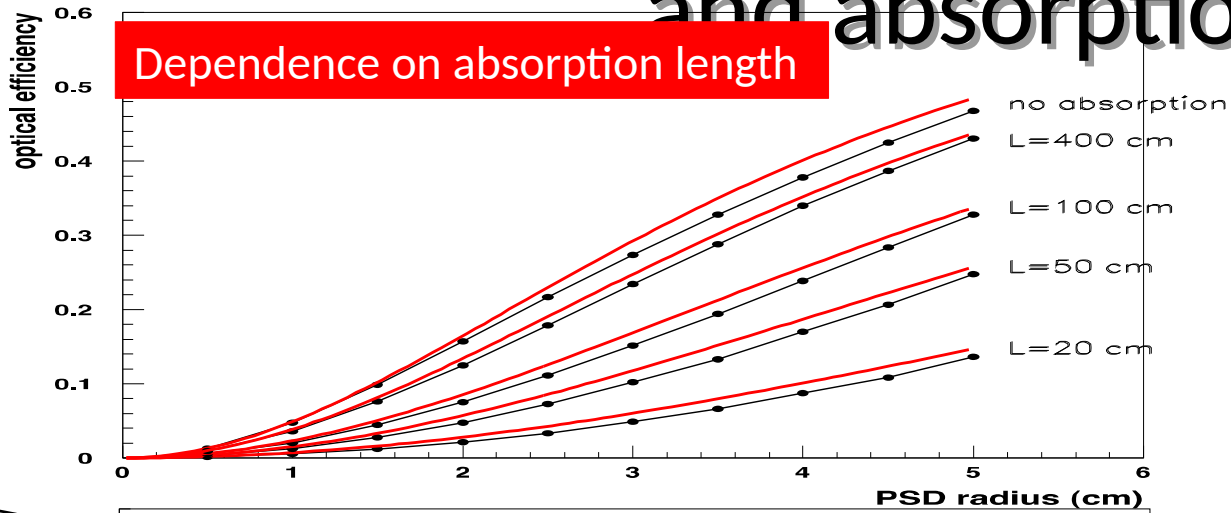

1 PSD
Specular reflectivity
R = 0.95
Rayleigh scattering = 10 cm

1 PSD
PSD radius = 4 cm
Specular reflectivity
R = 0.95
Absorption length = 50 cm

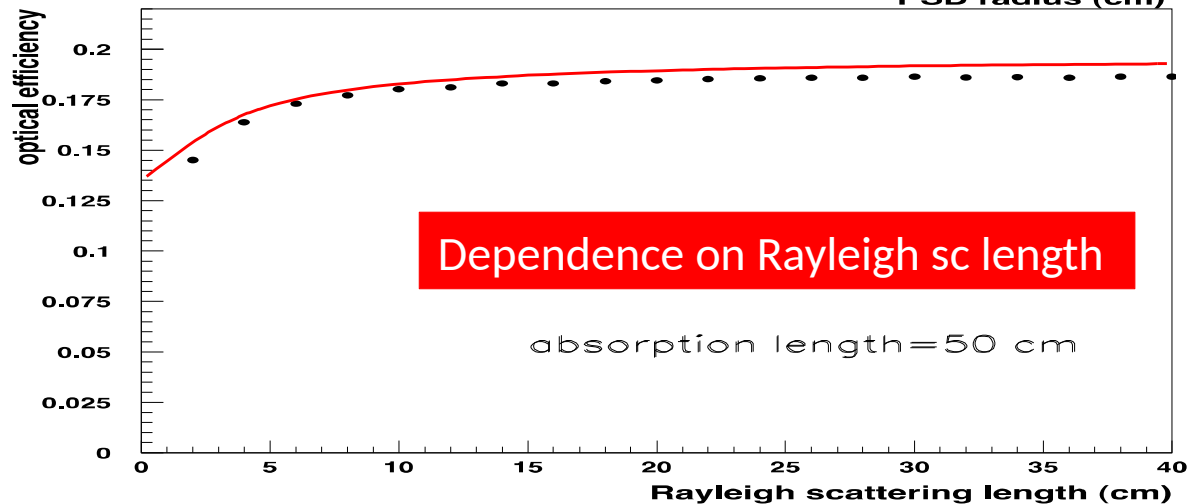

$$U_{RA} = \frac{\tilde{\lambda}}{\tilde{L}} (1 - e^{-\tilde{L}/\tilde{\lambda}})$$

Monte Carlo tests of the model: Parallelepiped



- ✓ Parallelepiped 10 cm × 10 cm × 30 cm ($l \times w \times h$).
- ✓ 2 PSDs on the opposite faces
- ✓ Windows' reflectivity is set at 0.3 and transmissivity at 0.5 (as for the cubic scintillator)

Parallelepiped (cont.)

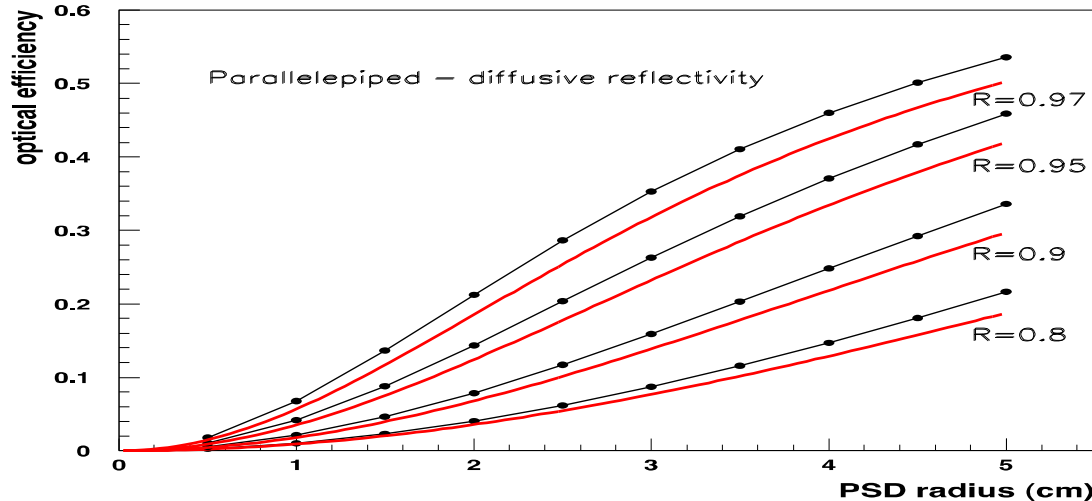
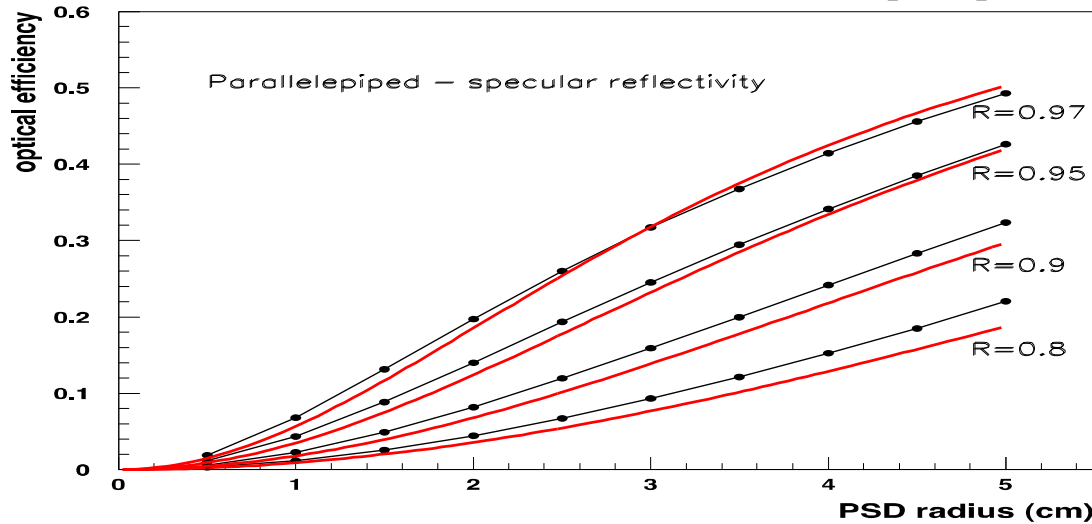

RED LINES :

$$\varepsilon_{opt} = \frac{T_w f}{1 - R(1 - f) - R_w f}$$

Extremely asymmetric detector

- ✓ Surprisingly good agreement between MC simulation and model outcomes
- ✓ For specular reflectivity, above 0.9, discrepancies at the level of few percent are found
- ✓ In all other cases they are of the order of 10%.

LY estimation of a real detector

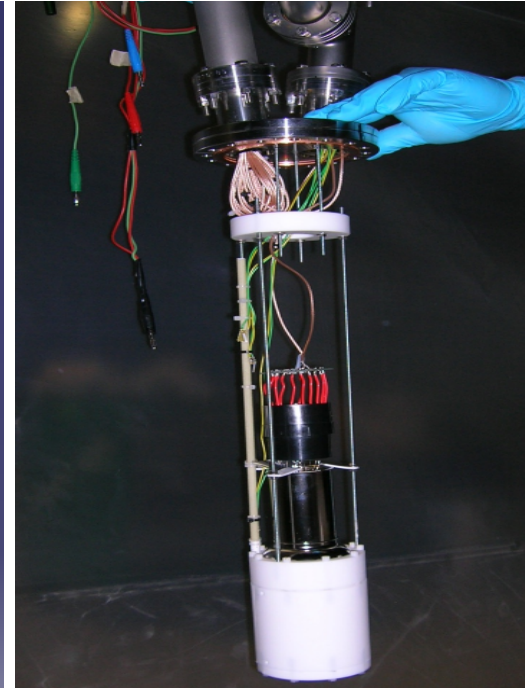
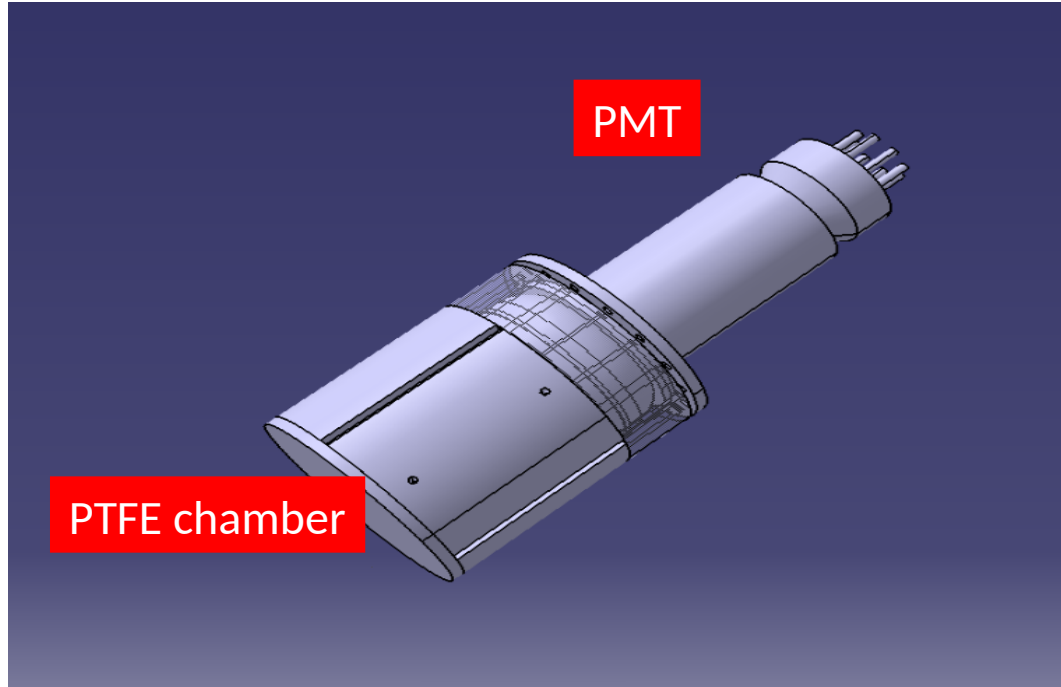

*LAr scintillation chamber - PTFE cell ($h = 9.0$ cm and $\varphi = 8.4$ cm) - observed by a single 3" photomultiplier (Hamamatsu R11065)
Internal surface of the cell completely covered with a reflective foil deposited with Tetra Phenyl Butadiene.*

WARP Collaboration, *Demonstration and comparison of photomultiplier tubes at liquid Argon temperature*, 2012 JINST 7 P01016 [arXiv:1108.5584].

LY estimation of a real detector (I)

Parameters used for LY estimation

photon yield	$N_\gamma = 40$ photons/keV [11]
photocathodic coverage	$f = 13\%$
transmissivity of PMT window	$T_w = 0.94$ [12]
reflectivity of PMT window	$R_w = 0$
conversion efficiency of PMT	$\epsilon_{PSD} = 28\%$
no absorption of VUV photons	$Q_{VUV} = 1$
no absorption of visible photons	$Q_{vis} = 1$
conversion efficiency of passive surface	$\epsilon_{WLS} = 1$ [13]
conversion efficiency of PMT window (no shifter)	$\epsilon_{wls} = 0.$
reflectivity of passive surface (reflector+TPB)	$R = 0.95$ [14]

LAr is assumed to be pure => no absorption ($Q = 1$)

Photons converted on the walls

$$LY_{estimated} = N_\gamma \epsilon_{PSD} \epsilon_{WLS} (1 - f) \frac{T_w f}{1 - R(1 - f)} = 6.9 \frac{phel}{keV}$$

$$LY_{measured} = 7 \frac{phel}{keV} \pm 5\%$$